



**Concrete Batching Plants responds to different needs with its professionally trained and experienced staff in the project and on the construction site.**

[www.asurmakina.com.tr](http://www.asurmakina.com.tr)

**ENGLISH 2023**

**PRODUCT CATALOGUE**

# ABOUT US

Our company was established in 2012 in Ankara. Our company produces Concrete Batching Plants that meet various needs with its experienced staff in the project and construction site, trained at a professional level with many years of experience in the sector.

Due to the concrete plants, it has produced and its customer-oriented solutions, it has succeeded in taking its place in the sector. It has adopted a customer-oriented working approach with design, manufacturing, production quality and workmanship, assembly operation, and after-sales Technical Service and has adopted it as a quality policy.

Due to its young dynamic teams, it continues to serve in this field and to find new solutions by following the developing technology.

**Asurmak Engineering A.Ş.** To be a brand with the principle of sustainable development in the light of developing technology with its team spirit and employees who adopt the happiness of its stakeholders who are sensitive to society and the environment.

Aiming to deliver the best quality concrete batching plant to its clients and to provide full customer satisfaction, it offers its clients to operate concrete batching plants with low operating costs for many years.

**Asurmak Engineering** The vision of the family is to make the added value of the company and its subsidiaries' projects and products feel at every point in the society's economy and social development and to present the surplus values it has obtained to the country's economy.

Our company, which has been providing the highest quality service as a professional solution partner with the fixed concrete batching plants it has produced since 2012, responds to every need in the production of the stationary concrete batching plants you need.

### Stationary Concrete Batching Plant

With a capacity of 35 m<sup>3</sup>, 60 m<sup>3</sup>, 100 m<sup>3</sup>, 120 m<sup>3</sup>, 160 m<sup>3</sup>, and 200 m<sup>3</sup> compacted concrete volumes, we manufacture stationary concrete batching plants that meet your needs most ergonomically in ever field. You can buy stationary concrete batching plants, which are state-of-the-art productions with mixer features, water pump compressors, bucket stad, close sisilosat the most economical prices, and you can do all your concrete works in the highest quality by mixing materials such as aggregate, water, and cement in the required proportions.

### Stationary Concrete Plant Specifications

Mixing type, mixer capacity, mixer motor power, cement silo, cement helix, and water weighing capacity, the plants you need in stationary concrete batching plants that respond most effectively to different needs are in our company. Our company, which is the most reliable addressing the sector with its strong references, closely follows the developments in the sector by using computer-equipped technologies.

### Stationary Concrete Batching Plants for Large Projects

Ready-mixed concrete of the desired quality is produced in stationary concrete plants, which have been used for many years without any problems. Stationary concrete batching plants, which have all the features needed in the ready-mixed concrete sector in line with the needs of the users, are indispensable machines for long-lasting projects. It has a Urea1 system and provides ready-mixed concrete of the desired quality. Our company, which installed the power plant you chose on the land you need, is the company you are looking for with its experienced staff and equipment in the sector.

### Service Guaranteed Stationary Concrete Batching Plants

Our company, which has many types of fixed concrete batching plants with different concrete volumes from 35 m<sup>3</sup> to 200 m<sup>3</sup>, offers its products to its customers under warranty. By purchasing a stationary concrete batching plant from a competent company, you can benefit from the advantages of our company and have the best quality fixed concrete batching plant under warranty at the most economical prices. Let us know the stationary concrete batching plant you need by contacting us on our website, and we will help you immediately with the stationary concrete batching plants that you will use for many years without any problem.

# ASURMAK STN- 35 M3



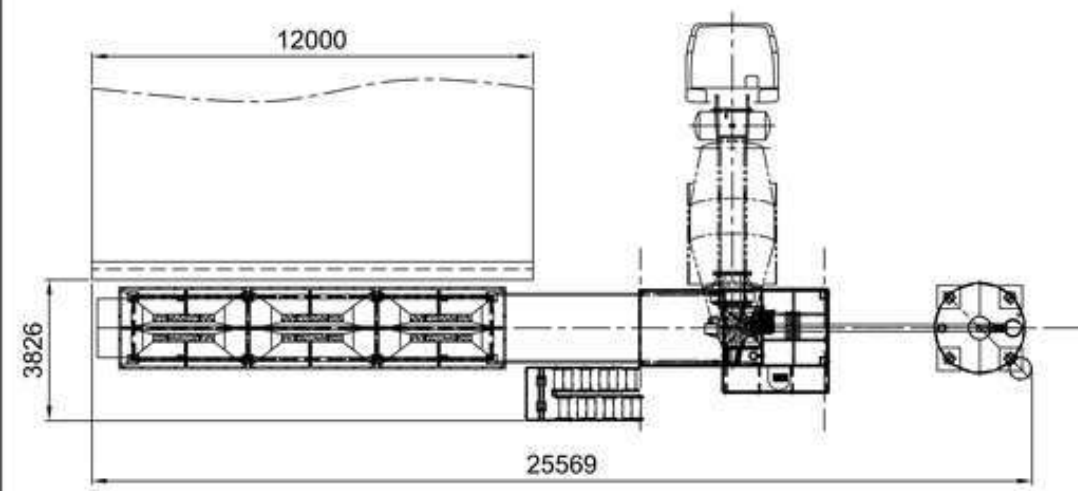
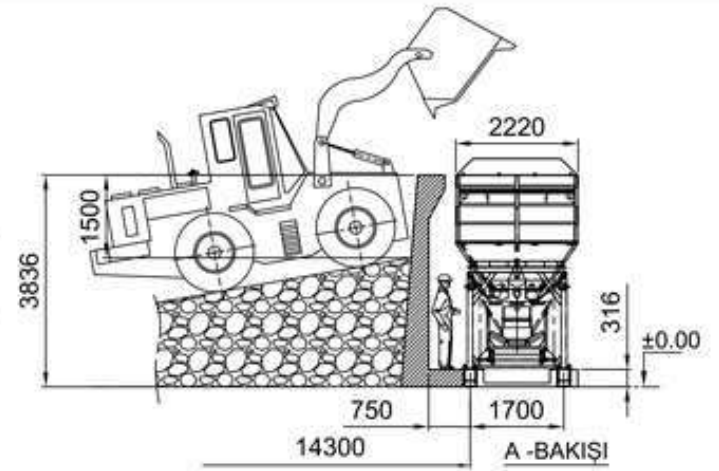
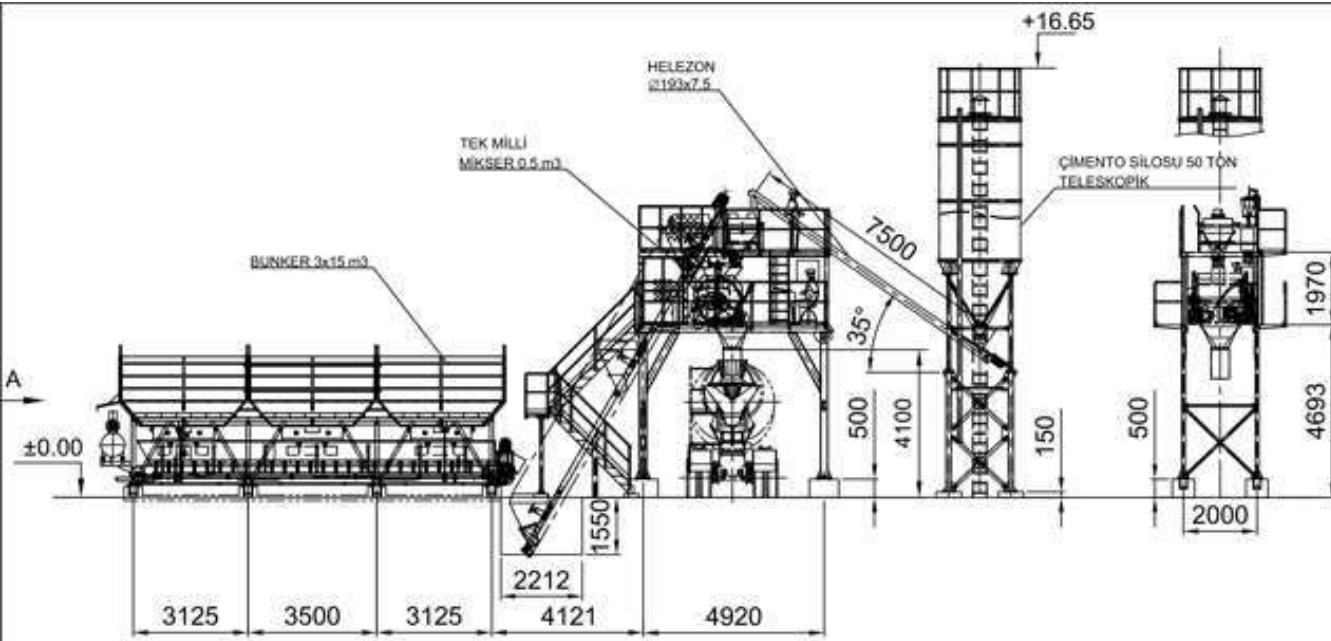

TİP DİZİMİ 1	TİP PLAN GENİRLİK 14300 mm
<b>ÇİMENTO SİLOSU VE ANA SAŞE</b>	
UZUNLUK : 14300 mm	
YÜKSEKLİK : 2450 mm	
GENİŞLİK : 3150mm	
13600	2490
TİP DİZİMİ 2	TİP PLAN GENİRLİK 13600 mm
<b>3x15 BUNKER</b>	
UZUNLUK : 13600 mm	
YÜKSEKLİK : 2280 mm	
GENİŞLİK : 2490mm	
13600	2490
BİLGİ AMAÇLIYR YÜKLEME ESNASINDA DEĞİŞİKLİK OLABİLİR	

## TEKNİK ÖZELLİKLER/TECHNICAL SPECIFICATIONS

<b>Santral Kapasitesi/plant Capacity</b>	
Sıkıştırılmış beton/Compacted Concrete	35 m <sup>3</sup> /h
Krişim Zamanı/Mixer Specifications	60 cycle/h
<b>Mikser Özellikleri/Mixer Specifications</b>	
Mikser kapasitesi/mixer Capacity	0,5 m <sup>3</sup>
Kuru Hacim/ Dry Capacity	750 lt
Sıkıştırılmış Beton/compacted Concrete	500lt
Motor Gücü/Motor Power	18,5 kW
<b>Argrega Bunker/Aggregate Bunker</b>	
Göz adedi/Agg Compartments	3 units
Göz Kapasitesi/ Compartments capacity	15 m <sup>3</sup>
Toplam Kapasite/Total Capacity	45 m <sup>3</sup>
<b>Argrega Tartım Konveyörü/Aggregate Weighing Conveyor</b>	
Genişlik/Width	800mm
Uzunluk/Lenght	9850 mm
Motor gücü/Motor Power	7,5 kW
<b>Kova/Skip Hoist</b>	
Kuru Yükleme Kapasitesi/Dry Load Capacity	750 lt
Maksimum Yükleme Kapasitesi/Max Load Capacity	1100 kg
Motor gücü/Motor Power	7,5 kW
Kova Hızı/Speed hoist up down	0,4 m/sn.
<b>Toplam Motor Gücü/Total Motor Power</b>	
Standart Tek silolu/Standart One Silo	50 kW

<b>Argrega Tartım/Aggregate Weighing</b>	1100kg
<b>Kantarlar/Weighers</b>	
Çimento Tartım/Cement Weighing	300 kg
Su Tartım/Su Weighing	150 kg
Katkı Tartım/Additive Weighing	20 kg
<b>Çimento helazonu/Cement Screw Conveyor</b>	
Çap/Diameter	193 mm
Uzunluk/Lenght	7500 mm
Motor Gücü/motor power	7,5kW
<b>Çimento Silosu/Cement Silo</b>	
Kapasite/Capacity	50 Ton
Adet/Quantity	1-2 units
<b>Kompresör/Compressor</b>	
Kapasite/Capacity 300 lt Tank	514 lt/dk
Çalışma Basıncı/Working Pressure	4 bar
Motor Gücü/Motor Power	3 kW
<b>Su Pompası/Waer pump</b>	
Pompa/Pump	15 m <sup>3</sup> /h
Çalışma Basıncı/Working Pressure	2-4 bar

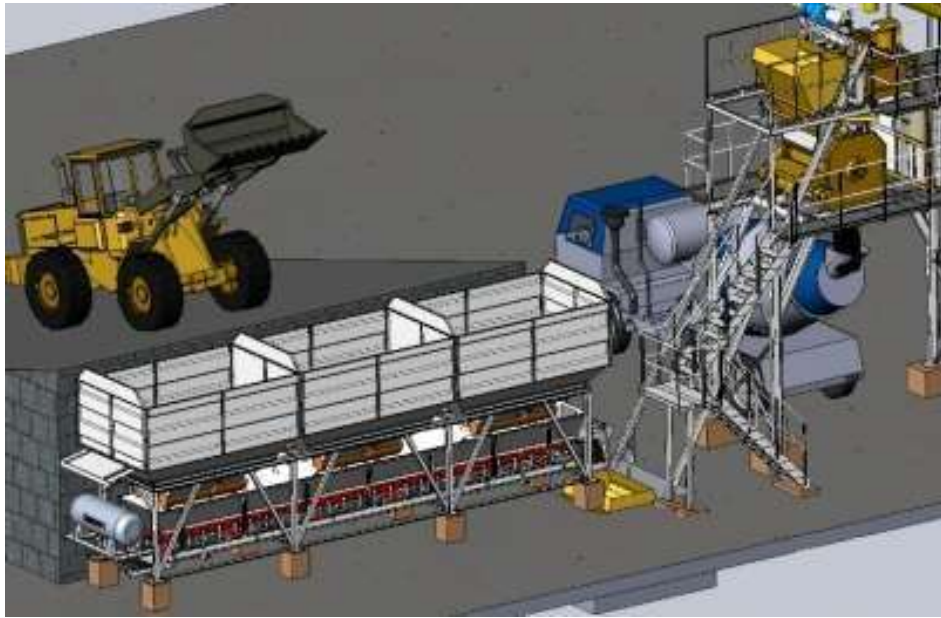
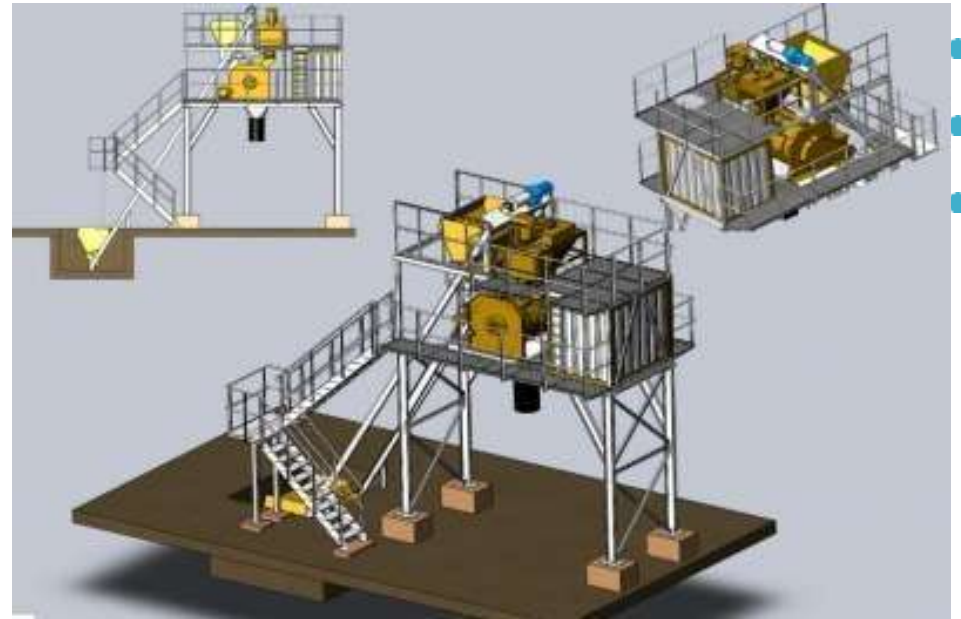
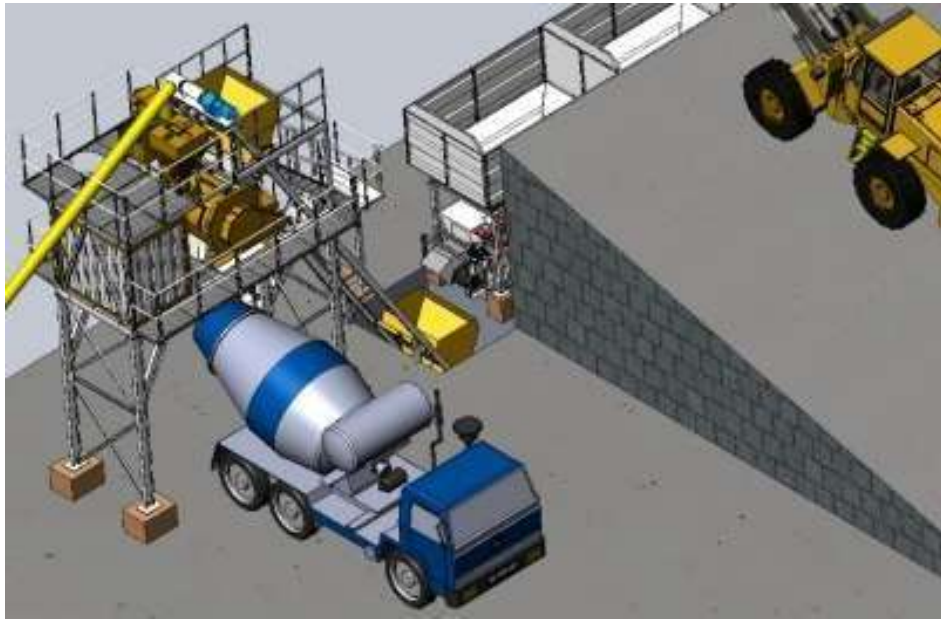

# ASURMAK STN-60 M3





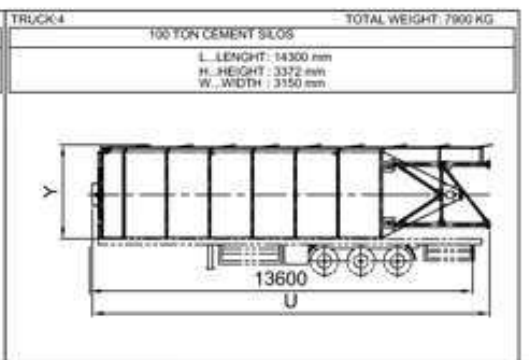
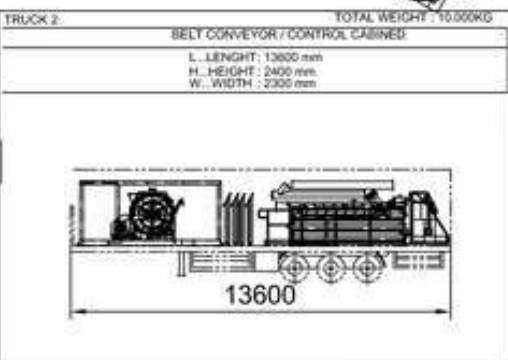
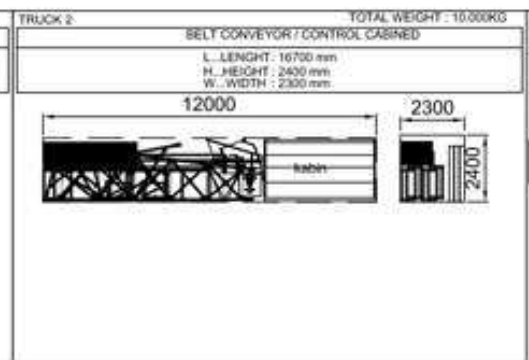
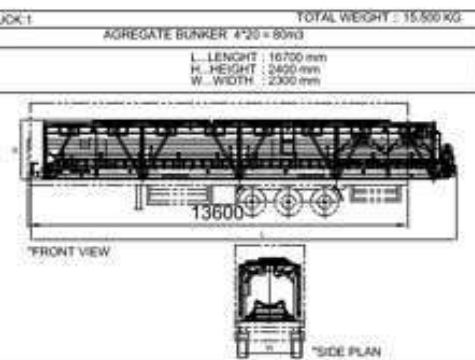
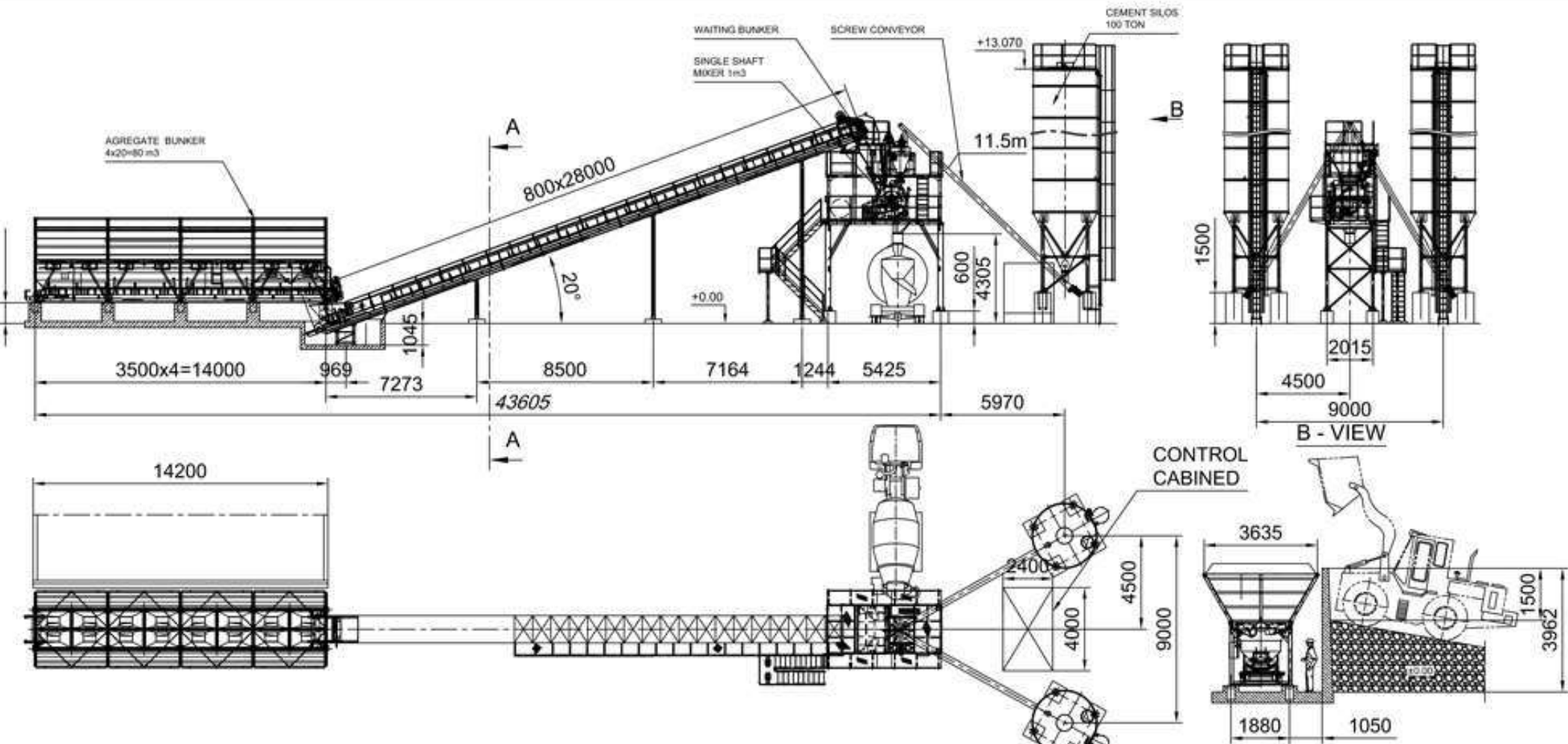

## TEKNİK ÖZELLİKLER/TECHNICAL SPECIFICATIONS

<b>Santral Kapasitesi/plant Capacity</b>	
Sıkıştırılmış beton/Compacted Concrete	60 m <sup>3</sup> /h
Krişim Zamanı/Mixer Specifications	60 cycle/h
<b>Mikser Özellikleri/Mixer Specifications</b>	
Mikser kapasites/mixer Capacity	1 m <sup>3</sup>
Kuru Hacim/ Dry Capacity	1500 lt
Sıkıştırılmış Beton/compacted Concrete	1000lt
Motor Gücü/Motor Power	37 kW
<b>Agrega Bunker/Aggregate Bunker</b>	
Göz adedi/Agg Compartments	4 units
Göz Kapasitesi/ Compartments capacity	20 m <sup>3</sup>
Toplam Kapasite/Total Capacity	80 m <sup>3</sup>
<b>Agrega Tartım Konveyörü/Aggregate Weighing Conveyor</b>	
Genişlik/Width	800mm
Uzunluk/Lenght	14350 mm
Motor gücü/Motor Power	7,5 kW
<b>Mikser Besleme Konveyörü/Mixer Feeding Conveyor</b>	
Genişlik/Width	800 mm
Uzunluk/Lenght	25000mm
Motor gücü/Motor Power	22 kW
<b>Toplam Motor Gücü/Total Motor Power</b>	
Standart Çift silolu/Standart Twin Silo	110 kW

Agrega Bekletme /aggregate waiting 2200kg

### Kantarlar/Weighers

Çimento Tartım Tartım/Cement Weighing	550 kg
Su Tartım/Su Weighing	250 kg
Katkı Tartım/Additive Weighing	20 kg

### Çimento helezonu/Cement Screw Conveyor

Çap/Diameter	219 mm
Uzunluk/Lenght	11500 mm
Motor Gücü/motor power	11 kW

### Çimento Silosu/Cement Silo

Kapasite/Capacity	100 Ton
Adet/Quantity	2-4 units

### Kompresör/Compressor

Kapasite/Capacity 300 lt tank	514 lt/dk
Çalışma Basıncı/Working Pressure	4 bar
Motor Gücü/Motor Power	3 kW

### Su Pompası/Waer pump

Pompa/Pump	15 m <sup>3</sup> /h
Çalışma Basıncı/Working Pressure	2-4 bar



# ASURMAK STN-100 M3



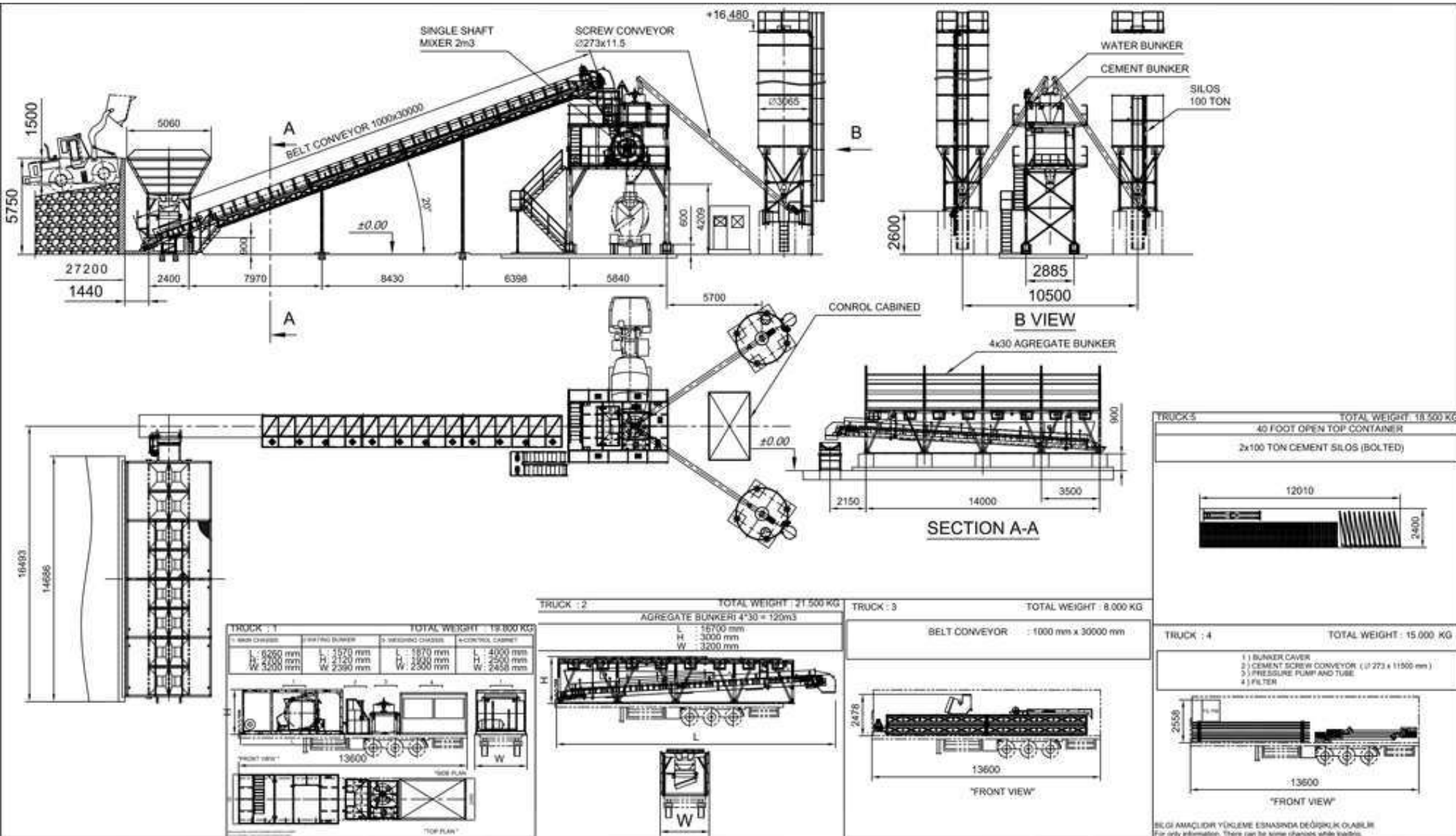

BİLGİ AMAÇLIDIR YÜKLEME ESNASINDA DEĞİŞİKLİK OLABİLİR  
For only information. There can be some changes while loading.

## TEKNİK ÖZELLİKLER/TECHNICAL SPECIFICATIONS

<b>Santral Kapasitesi/plant Capacity</b>	
Sıkıştırılmış beton/Compacted Concrete	100 m3/h
Krişim Zamanı/Mixer Specifications	50 cycle/h
<b>Mikser Özellikleri/Mixer Specifications</b>	
Mikser kapasites/mixer Capacity	2,0 m3
Kuru Hacim/ Dry Capacity	3000 lt
Sıkıştırılmış Beton/compacted Concrete	2000lt
Motor Gücü/Motor Power	2X37 kW
<b>Argrega Bunker/Aggregate Bunker</b>	
Göz adedi/Agg Compartments	4 units
Göz Kapasitesi/ Compartments capacity	25 m3
Toplam Kapasite/Total Capacity	100 m3
<b>Argrega Tartım Konveyörü/Aggregate Weighing Conveyor</b>	
Genişlik/Width	800mm
Uzunluk/Lenght	14350 mm
Motor gücü/Motor Power	7,5 kW
<b>Mikser Besleme Konveyörü/Mixer Feeding Conveyor</b>	
Genişlik/Width	1000 mm
Uzunluk/Lenght	28000mm
Motor gücü/Motor Power	30 kW
<b>Toplam Motor Gücü/Total Motor Power</b>	
Standart Çift silolu/Standart Twin Silo	215 kW

Agrega Bekletme /aggregate waiting	4400kg
<b>Kantarlar/Weighers</b>	
Çimento Tartım Tartım/Cement Weighing	1000 kg
Su Tartım/Su Weighing	7000 kg
Katkı Tartım/Additive Weighing	20 kg
<b>Çimento helezonu/Cement Screw Conveyor</b>	
Çap/Diameter	273 mm
Uzunluk/Lenght	11500 mm
Motor Gücü/motor power	15 kW
<b>Çimento Silosu/Cement Silo</b>	
Kapasite/Capacity	100 Ton
Adet/Quantity	2-4 units
<b>Kompresör/Compressor</b>	
Kapasite/Capacity	1800 lt/dk
Çalışma Basıncı/Working Pressure	7,5 bar
Motor Gücü/Motor Power	7,5 kW
<b>Su Pompası/Waer pump</b>	
Pompa/Pump	25 m3/h
Çalışma Basıncı/Working Pressure	2-4 bar

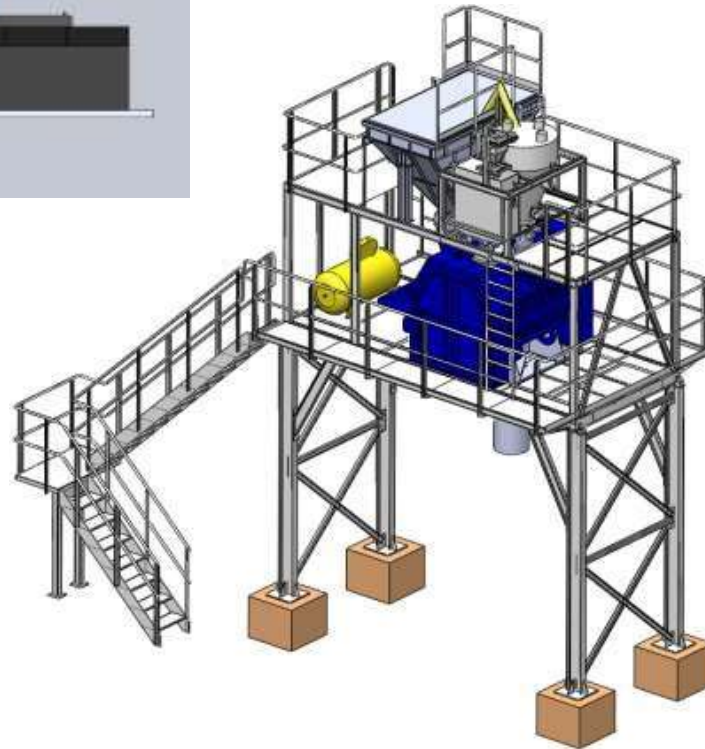
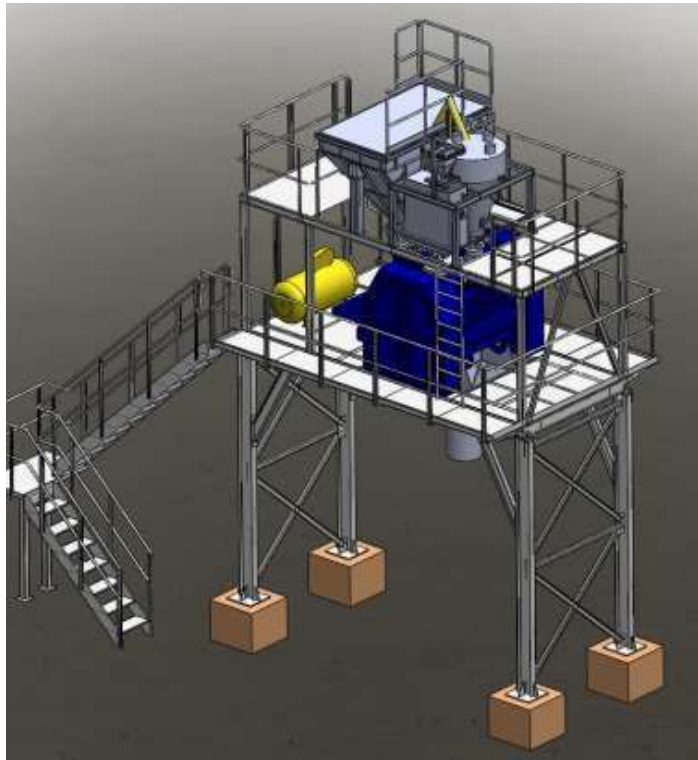
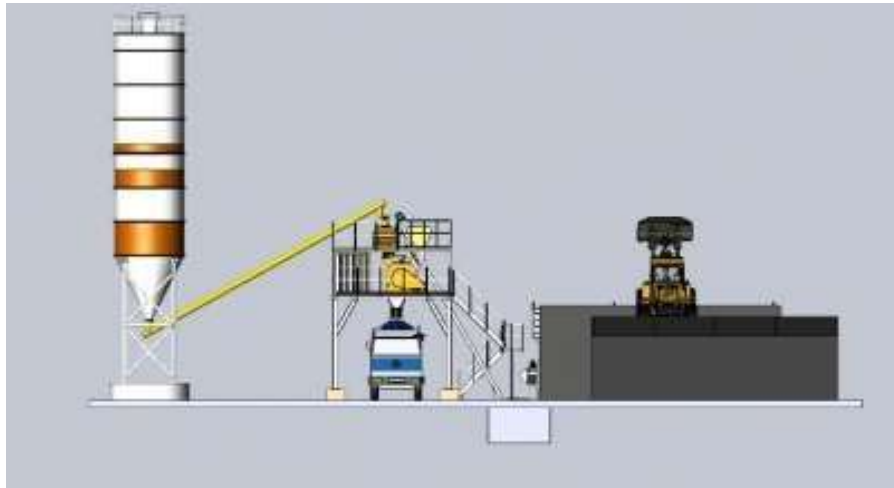

# ASURMAK STN-120 M3





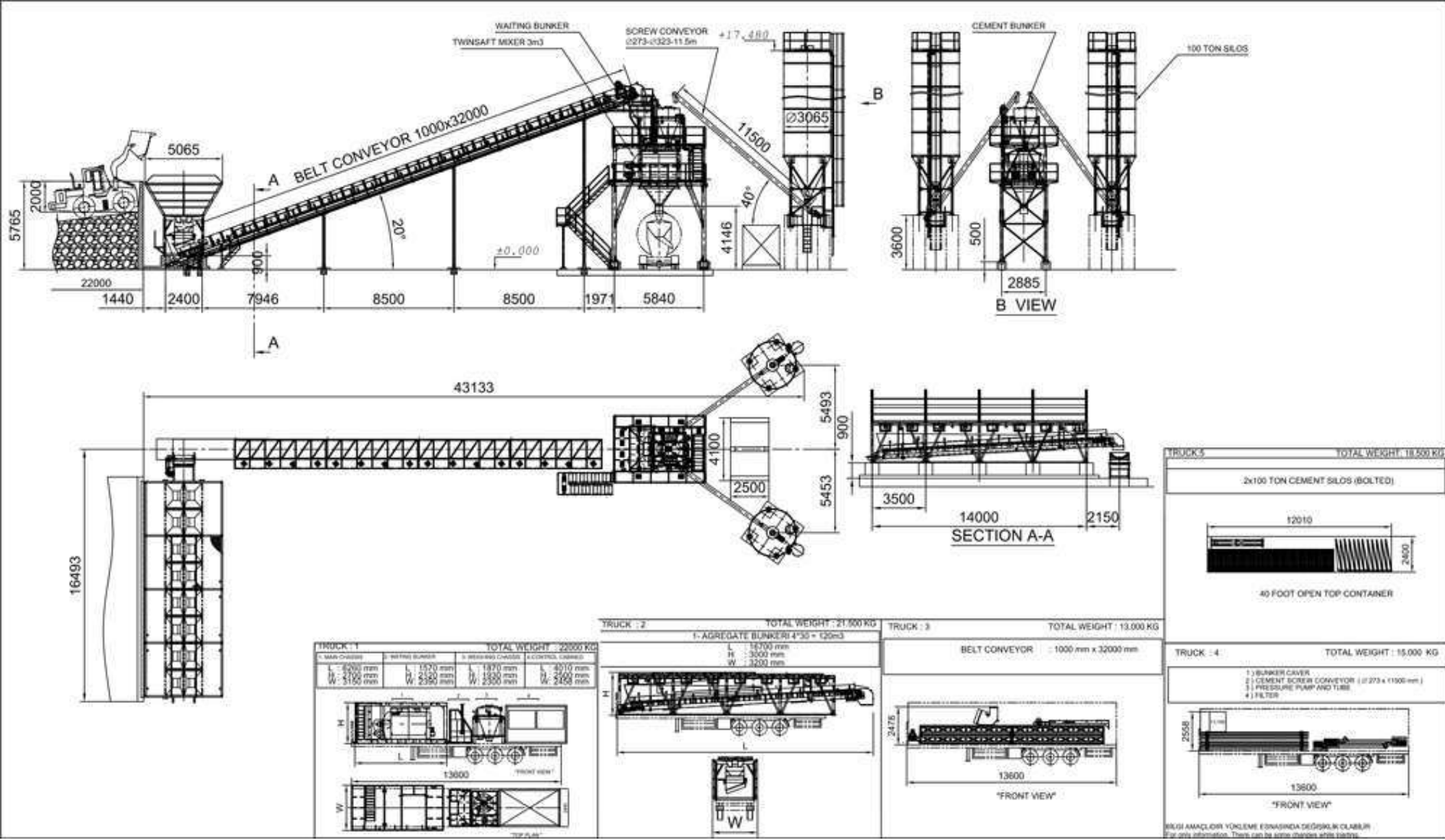

MÜŞİ AMAÇLARI YÖZÜME EKİNİNDE DEĞİŞİKLİK OLABİLİR  
 For only information. There can be some changes with loading.

## TEKNİK ÖZELLİKLER/TECHNICAL SPECIFICATIONS

<b>Santral Kapasitesi/Plant Capacity</b>	
Sıkıştırılmış beton/Compacted Concrete	120 m <sup>3</sup> /h
Krişim Zamanı/Mixer Specifications	40 cycle/h
<b>Mikser Özellikleri/Mixer Specifications</b>	
Mikser kapasites/mixer Capacity	3 m <sup>3</sup>
Kuru Hacim/ Dry Capacity	4500 lt
Sıkıştırılmış Beton/compacted Concrete	3000lt
Motor Gücü/Motor Power	2x55 kW
<b>Agrega Bunker/Aggregate Bunker</b>	
Göz adedi/Agg Compartments	4 units
Göz Kapasitesi/ Compartments capacity	30 m <sup>3</sup>
Toplam Kapasite/Total Capacity	120 m <sup>3</sup>
<b>Agrega Tartım Konveyörü/Aggregate Weighing Conveyor</b>	
Genişlik/Width	1000mm
Uzunluk/Lenght	15350mm
Motor gücü/Motor Power	15 kW
<b>Mikser Besleme Konveyörü/Mixer Feeding Conveyor</b>	
Genişlik/Width	1000mm
Uzunluk/Lenght	32000 mm
Motor gücü/Motor Power	37 kW
<b>Toplam Motor Gücü/Total Motor Power</b>	
Standart Çift silolu/Standart Twin Silo	215 kW

Agrega Bekletme /aggregate waiting	4 m <sup>3</sup>
<b>Kantarlar/Weighers</b>	
Çimento Tartım/Cement Weighing	1600
Su Tartım/Su Weighing	750 kg
Katkı Tartım/Additive Weighing	50 kg
<b>Çimento helazonu/Cement Screw Conveyor</b>	
Çap/Diameter	273 mm
Uzunluk/Lenght	11500 mm
Motor Gücü/motor power	15 kW
<b>Çimento Silosu/Cement Silo</b>	
Kapasite/Capacity	100 Ton
Adet/Quantity	2-4 units
<b>Kompresör/Compressor</b>	
Kapasite/Capacity	2400 lt/dk
Çalışma Basıncı/Working Pressure	7,5 bar
Motor Gücü/Motor Power	18,5 kW
<b>Su Pompası/Waer pump</b>	
Pompa/Pump	50 m <sup>3</sup> /h
Çalışma Basıncı/Working Pressure	2-4 bar

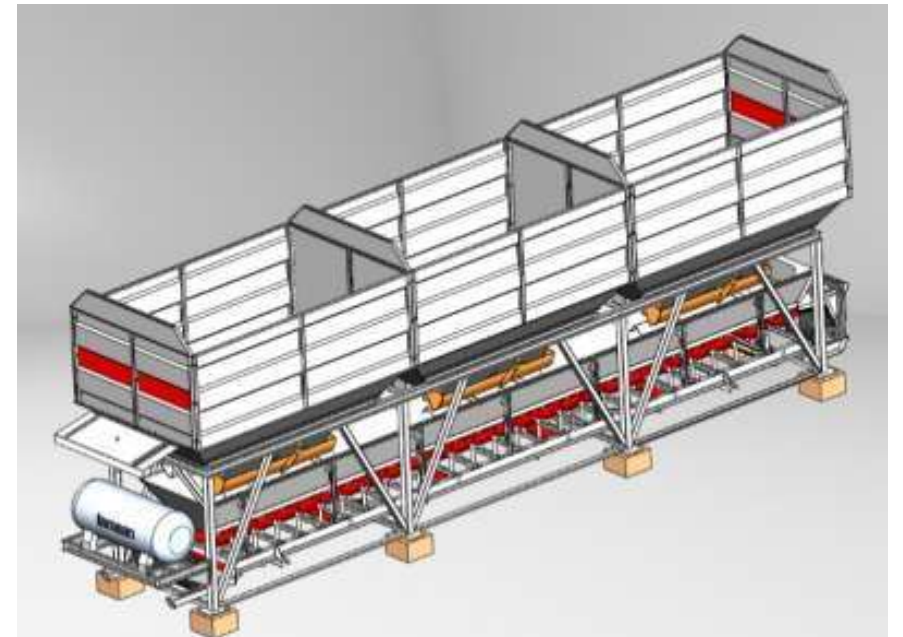
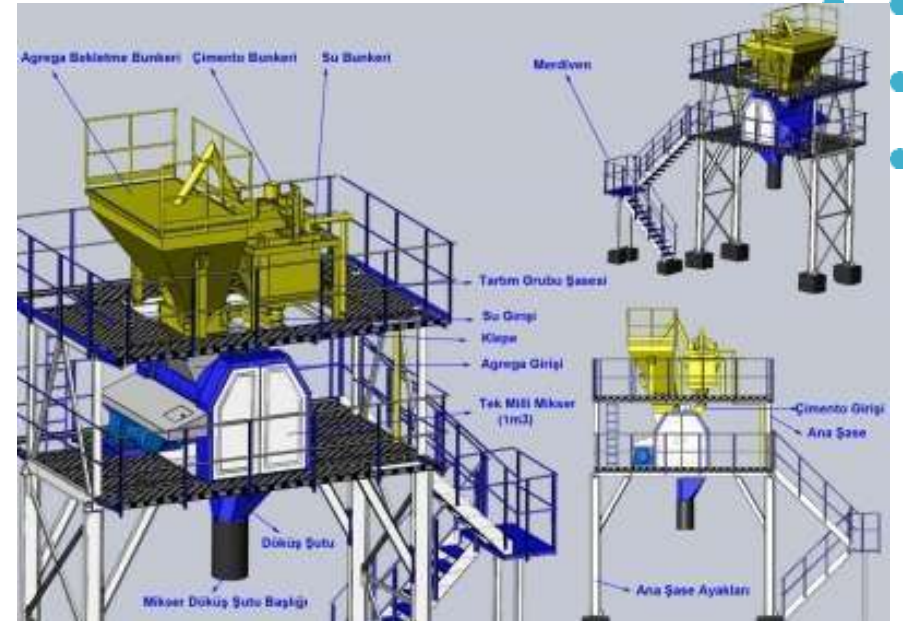
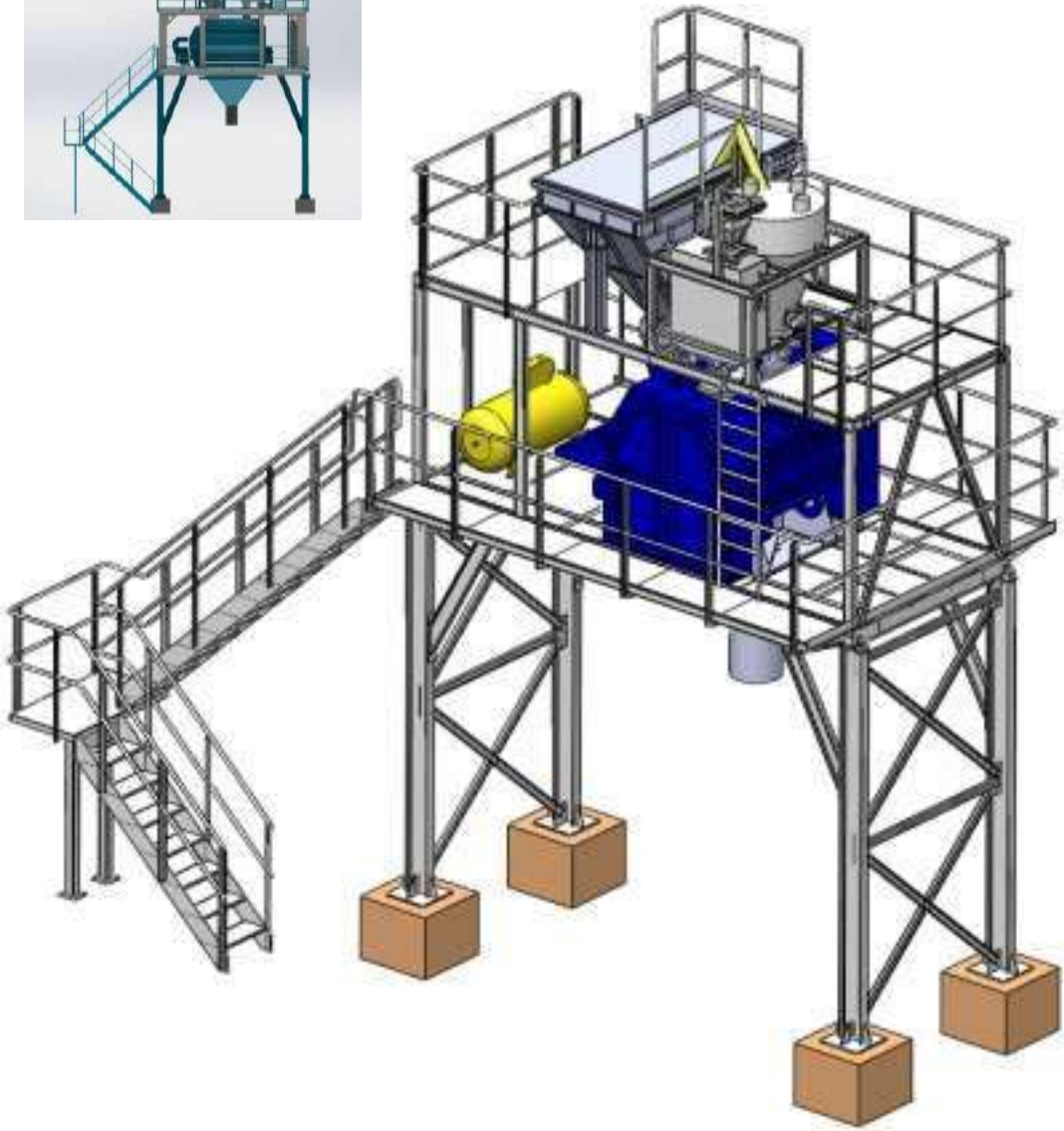

# ASURMAK STN 160 M3



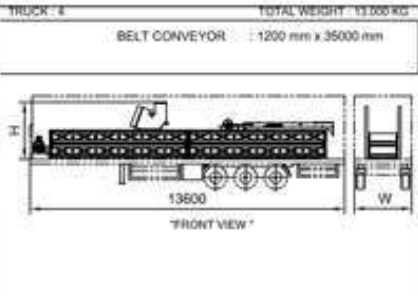
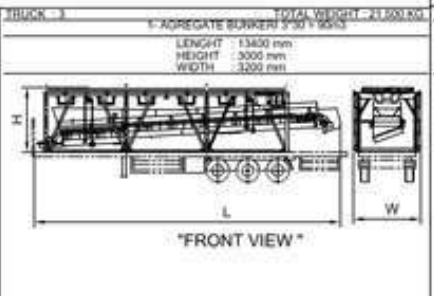
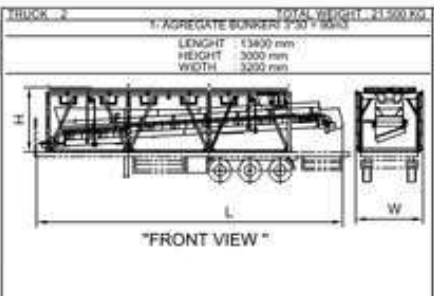
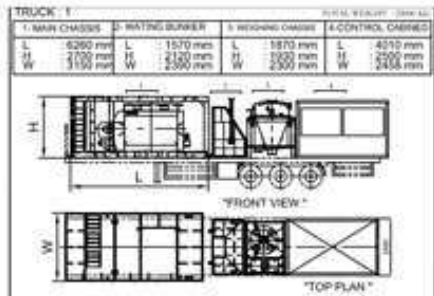
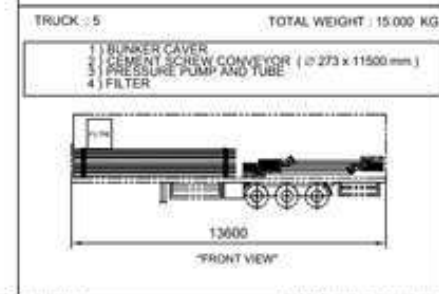
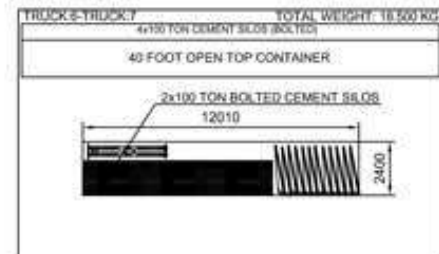
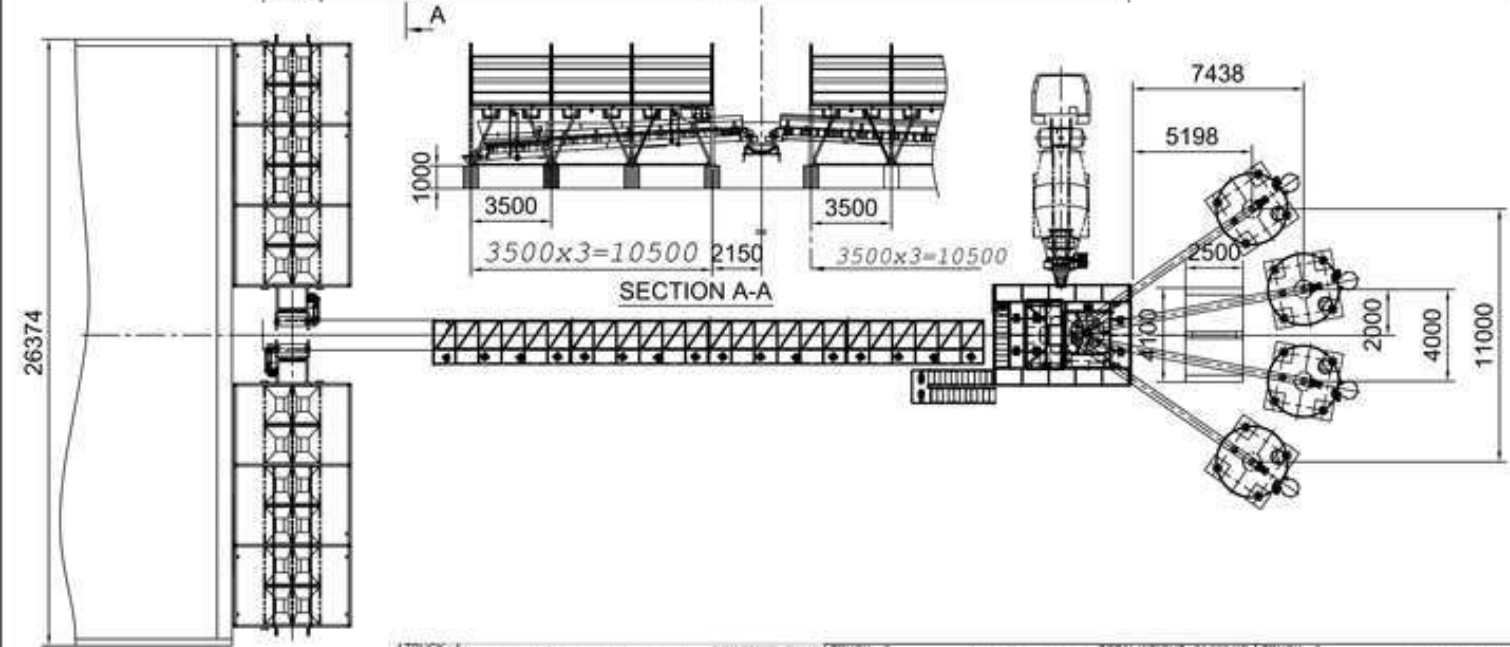
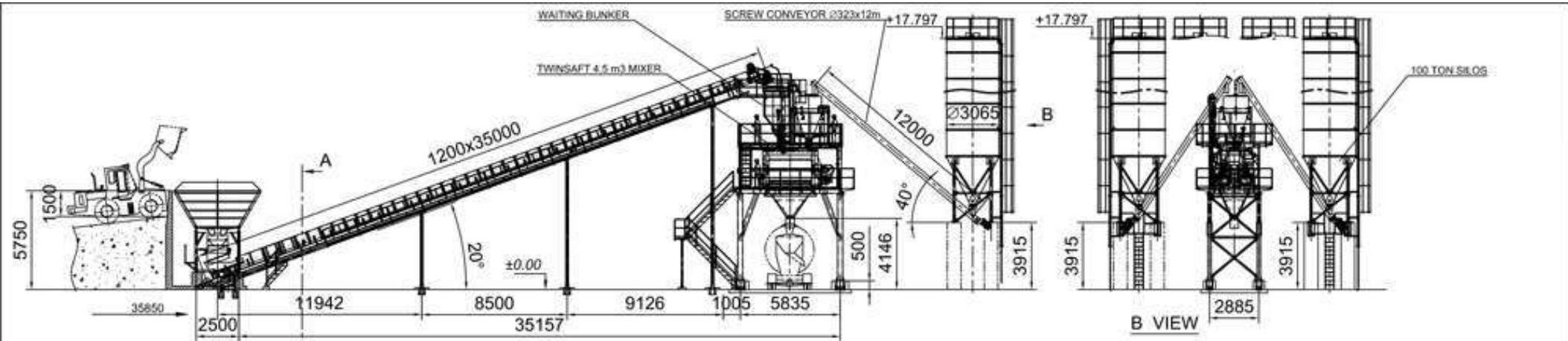

## TEKNİK ÖZELLİKLER/TECHNICAL SPECIFICATIONS

<b>Santral Kapasitesi/plant Capacity</b>	
Sıkıştırılmış beton/Compacted Concrete	160 m3/h
Krişim Zamanı/Mixer Specifications	40 cycle/h
<b>Mikser Özellikleri/Mixer Specifications</b>	
Mikser kapasites/mixer Capacity	4 m3
Kuru Hacim/ Dry Capacity	6000 lt
Sıkıştırılmış Beton/compacted Concrete	4000lt
Motor Gücü/Motor Power	2x75 kW
<b>Argrega Bunker/Aggregate Bunker</b>	
Göz adedi/Agg Compartments	4 units
Göz Kapasitesi/ Compartments capacity	40 m3
Toplam Kapasite/Total Capacity	160 m3
<b>Argrega Tartım Konveyörü/Aggregate Weighing Conveyor</b>	
Genişlik/Width	1000mm
Uzunluk/Lenght	15350mm
Motor gücü/Motor Power	22 kW
<b>Mikser Besleme Konveyörü/Mixer Feeding Conveyor</b>	
Genişlik/Width	1200mm
Uzunluk/Lenght	35000mm
Motor gücü/Motor Power	55 kW
<b>Toplam Motor Gücü/Total Motor Power</b>	
Standart Çift silolu/Standart Twin Silo	215 kW

Agrega Bekletme /aggregate waiting	4,5 m3
<b>Kantarlar/Weighers</b>	
Çimento Tartım Tartım/Cement Weighing	2000kg
Su Tartım/Su Weighing	1600 kg
Katkı Tartım/Additive Weighing	50 kg
<b>Çimento helazonu/Cement Screw Conveyor</b>	
Çap/Diameter	323 mm
Uzunluk/Lenght	12000 mm
Motor Gücü/motor power	18,5 kW
<b>Çimento Silosu/Cement Silo</b>	
Kapasite/Capacity	100 Ton
Adet/Quantity	2-4 units
<b>Kompresör/Compressor</b>	
Kapasite/Capacity	2400 lt/dk
Çalışma Basıncı/Working Pressure	7,5 bar
Motor Gücü/Motor Power	18,5 kW
<b>Su Pompası/Waer pump</b>	
Pompa/Pump	50 m3/h
Çalışma Basıncı/Working Pressure	2-4 bar

# ASURMAK STN-200 M3



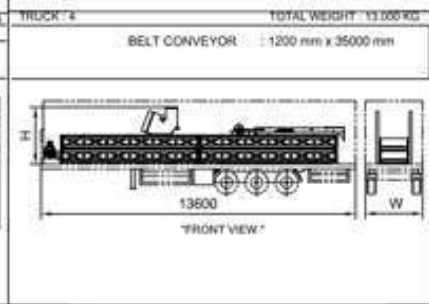
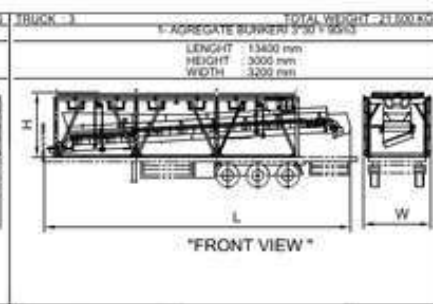
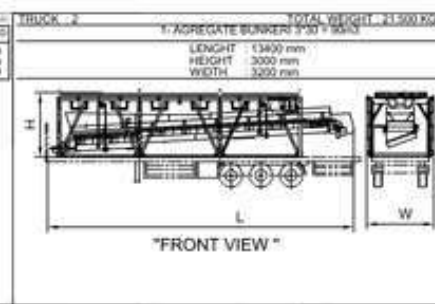
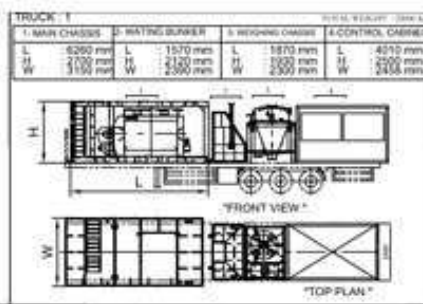
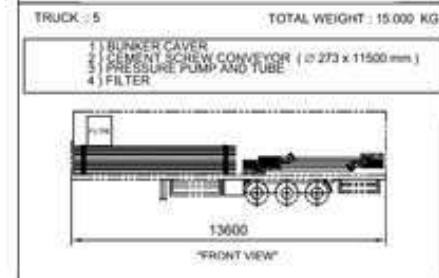
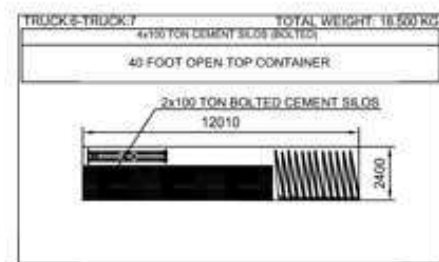
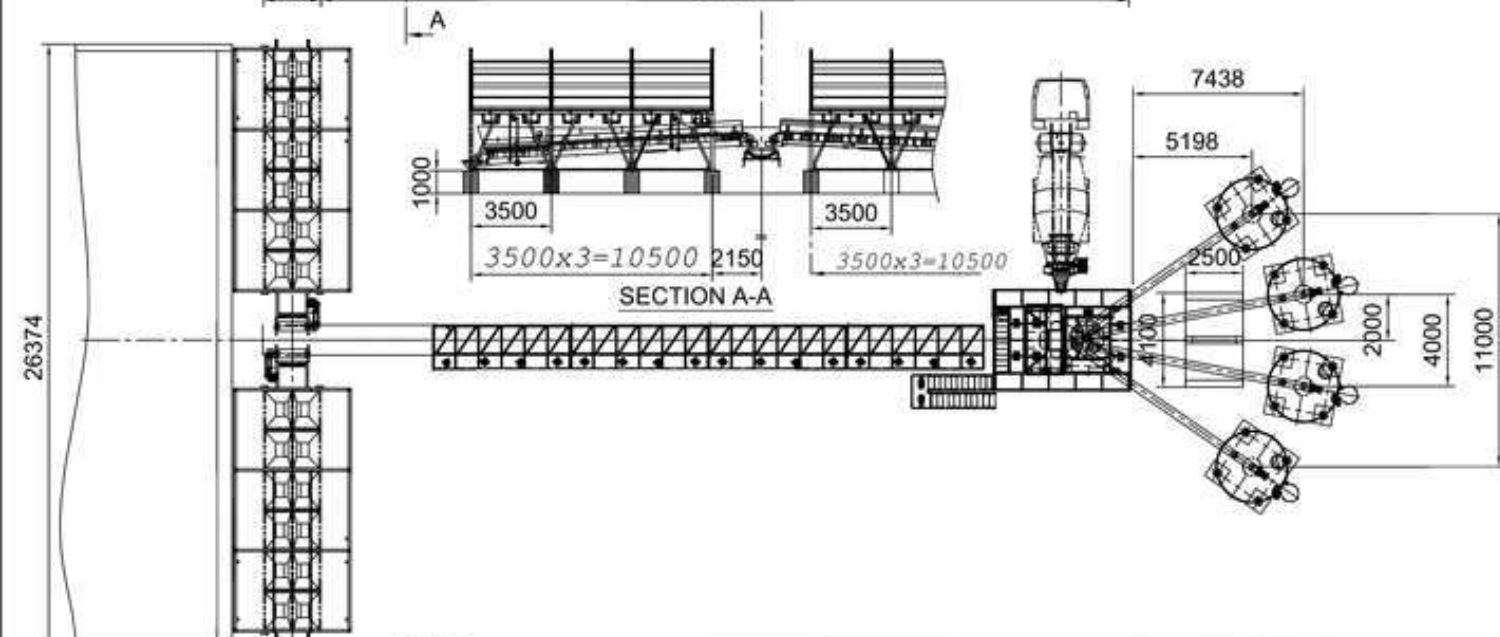
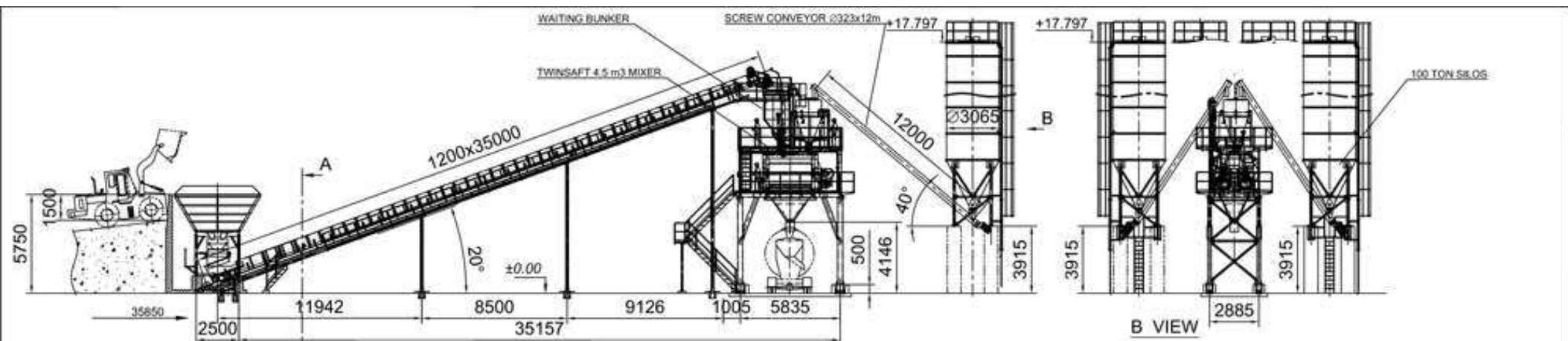



## Mobile Concrete Batching Plant Providing Fast and Easy Solutions

As a result of the developments and growth in the construction sector, the need for mobile concrete batching plants, one of the sector's basic building blocks, is increasing. The mobile concrete batching plant, which enables the production of ready-mixed concrete after the cement, aggregate, water, and all other chemicals are mixed with the determined dimensions, is set up and made ready much faster than the fixed concrete batching plants. This allows you to get your work done faster.

There is no need to carry out infrastructure works in places where mobile concrete batching plants will be installed. The mobile concrete batching plant, which enables to the production of ready-mixed content with cheap costs, has a feature that can be moved when necessary.

The installation costs of the mobile concrete batching plant, which has an extremely useful structure, are also lower than other concrete batching plants. The operation of the mobile concrete plant system is provided by the computer automation system. After the formulations of the substances that need to be mixed by the plant operator are entered into the mobile concrete plant, the weighed substances are thrown into the mixer and mixed automatically, and the concrete production is completed in a short time.

### Quality Concrete Production

One of the most important features of the mobile concrete plant is that it provides the desired quality of concrete production. The mobile concrete plant, which produces the best according to the proportions of the mixed materials, provides companies with great profits.

Asur mobile concrete batching plant, which is highly technologically produced, is specially produced according to the production volumes and demands of the companies. Companies that do intensive construction work should prefer mobile concrete batching plants with high volumes. Firms with less intensive production should prefer mobile concrete batching plants with low volume.

The mobile concrete batching plant, which is preferred by customers who want fast solutions in a shorter time, has low transaction costs due to its easy transportation and immediate assembly and disassembly. Asur mobile concrete plant, which produces 15 m<sup>3</sup>, 35 m<sup>3</sup>, 60 m<sup>3</sup>, 100 m<sup>3</sup>, and 120 m<sup>3</sup> concrete per hour, has become one of the indispensables of most projects due to its power and quality. As a result of the mobile concrete batching plant working with the computer system, it can intervene immediately to problems that may arise from production or misuse of the machine. This eliminates the chance of errors being overlooked.



# MINI MOBILE CONCRETE PLANT

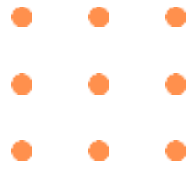

## SPECIFICATIONS

Capacity: 30 m<sup>3</sup>/h

Aggregate Bunker Capacity : 2x5 m<sup>3</sup> veya 4x5 m<sup>3</sup>

Aggregate Weighing Conveyor Capacity:  
Weighing is done in a mixer

Aggregate Loading Type: Transfer Band

Mixer Capacity: 750/500 L.

Mixer Type: Pan / Planetary

Cement Weighing Capacity: 300 kg

Water Weighing Capacity: 200 kg

Additive Weighing Capacity: 1x25 l (For one type of chemical Additive)

Control System: Included

Operator Station a -

Cement Screw Diameter: (Ø) Ø 165 mm

Compressor: Included



Mini Mobil Concrete Batching Plant, the latest product of the ASUR Makina innovation team, makes it possible to produce concrete in economic and international standards in small projects where the concrete need is relatively low. The advantages of the Mini Mobile Concrete Plant, which is ready for concrete production at the desired location in less than 1 hour, are gathered below.

- Craneless installation and relocation in a very short time (1 hour)
- Installation without the need for a concrete foundation
- Installation in a very narrow space
- Ability to be towed and transported on the highway
- Economic sea transportation (in one Container 40'ft Opentop with cement feeding system)
- Does not require permission for concrete production
- Minimum concrete transportation cost due to on-site installation
- High-quality and precise concrete production



# ASURMAK MCP-35 M3



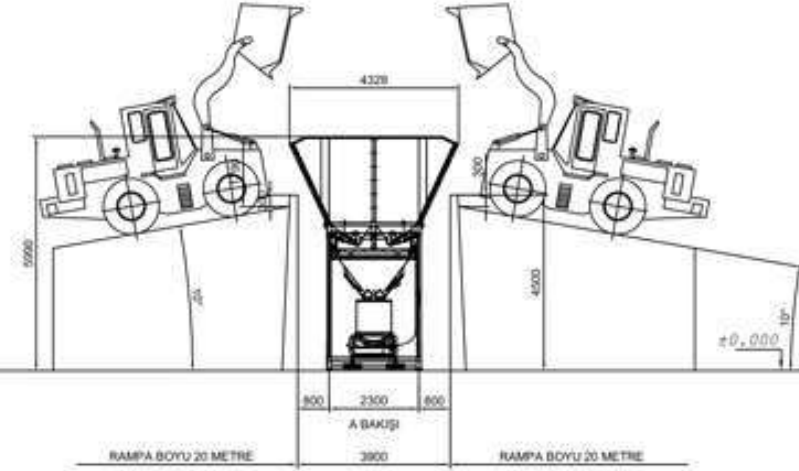
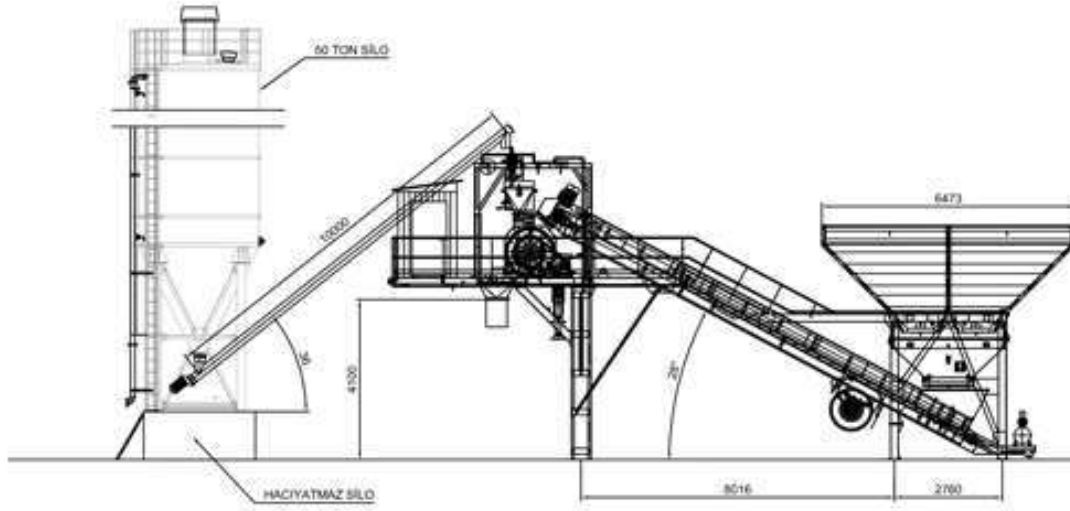

TOPLAM AĞIRLIK: 6500 KG

50 TON ÇİMENTO SİLOSU (KAYNAKLI)

UZUNLUK : 11300 mm  
YÜKSEKLİK: 3372 mm  
GENİŞLİK : 3150 mm

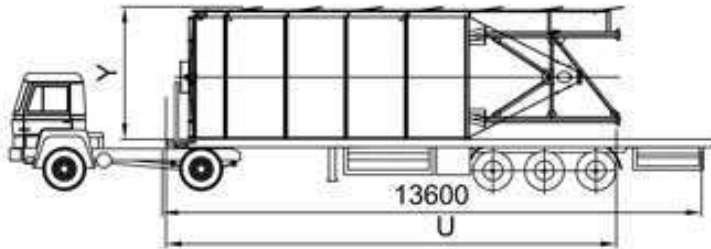

TOPLAM AĞIRLIK: 17000 KG

30 MOBİL BETON SANTRALİ

UZUNLUK : 17900 mm  
YÜKSEKLİK: 4500 mm  
GENİŞLİK : 2700 mm

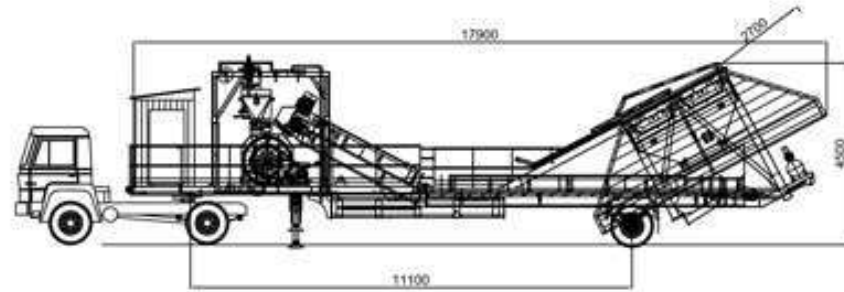

### 35 m3/h MOBİL BETON SANTRALİ TEKNİK ÖZELLİKLER

AGREGA BUNKERİ	4x10=40 m3	
AĞREGA TARTIM BUNKERİ	1100 kg	
MİKSER	0,5m3	TEK MİLLİ -ÇİFT MİLLİ-PLANET
HELEZON	193x6000	WAM
SİLO EKİPMANLARI	Silotop Filtre, Emniyet Valfi, Seviye Gös. Hava Jeti	WAM
ÇİMENTO TARTIM BUNKERİ	250 Kg	LOADCELL ZEMIC
SU TARTIM BUNKERİ	125 Kg	LOADCELL ZEMIC
KATKI BUNKERİ	20 Kg	LOADCELL ESİT-ZEMIC
AGREGA YÜKLEME BANDI	800X9850	7.5 KW
KOMPRESÖR	800 LT/DK 300 LT TANKLI	7,5 KW
KONTROL KABİNİ	NURİŞ	YALITIMLI
OTOMASYON	MAKRO OTOMASYON	SIMENS



# ASURMAK MCP-60 M3



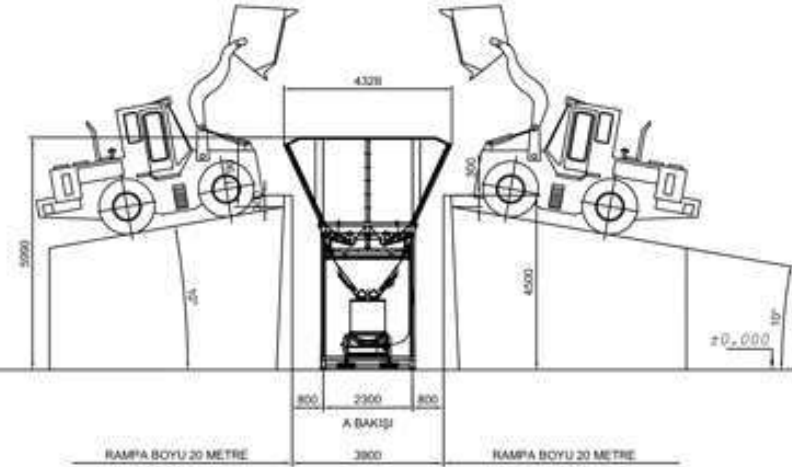
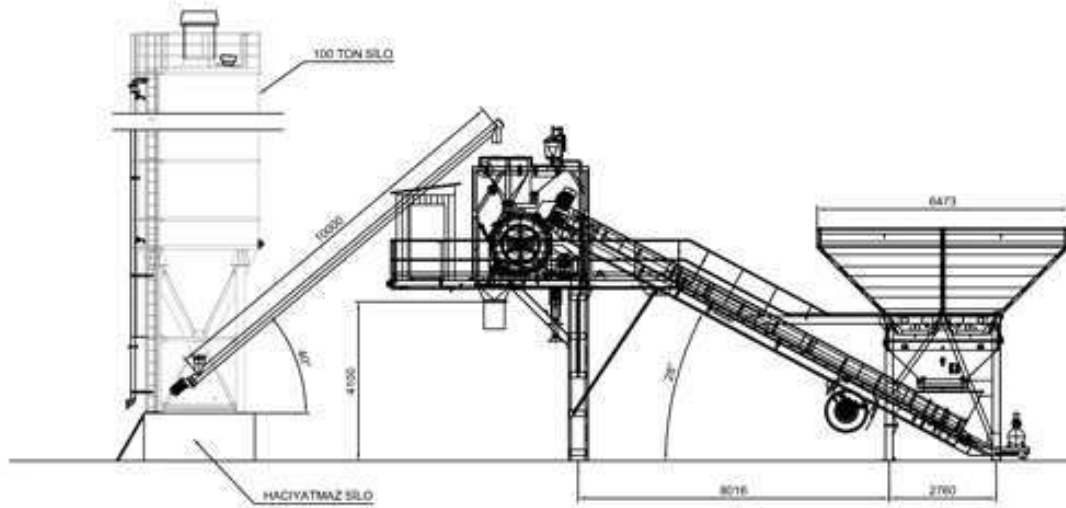

TOPLAM AĞIRLIK: 7900 KG

100 TON ÇİMENTO SİLOSU (KAYNAKLI)

UZUNLUK : 14300 mm  
YÜKSEKLİK: 3372 mm  
GENİŞLİK : 3150 mm

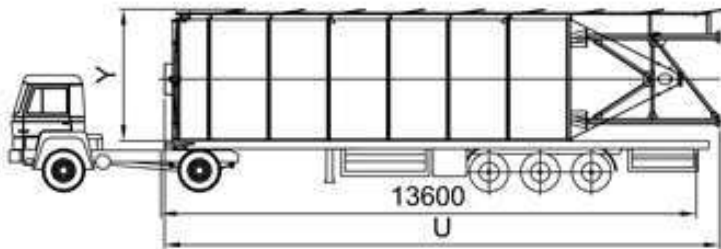

TOPLAM AĞIRLIK: 18000 KG

60 MOBİL BETON SANTRALI

UZUNLUK : 17900 mm  
YÜKSEKLİK: 4500 mm  
GENİŞLİK : 2700 mm

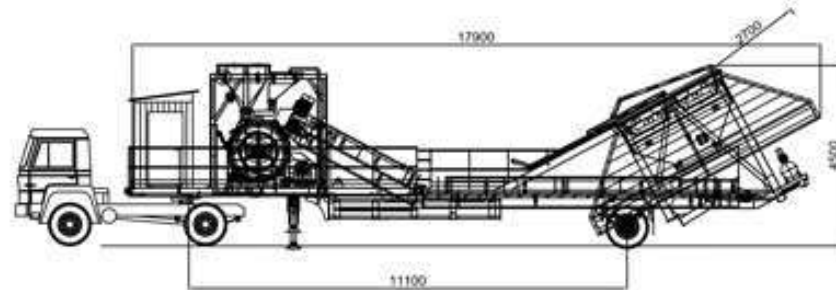



## 60 m<sup>3</sup>/h MOBILE CONCRETE PLANT TECHNICAL SPECIFICATIONS

AGGREGATE BUNKER	4x10=40 m <sup>3</sup>	
AGGREGATE WEIGHING BUNKER	2500 kg	
MIXER	1 m <sup>3</sup>	SINGLE SHAFT -DOUBLE SHAFT-PLANET
SPIRAL	219x6000	WAM-OTS
SILO PIECES OF EQUIPMENT	Silotop Filter, Safety Valve, Level Display. Air Jet	WAM-OTS
CEMENT WEIGHING BUNKER	500 Kg	LOADCELL ESIT-ZEMIC
WATER WEIGHING BUNKER	250 Kg	LOADCELL ESIT-ZEMIC
ADDITIVE BUNKER	20 Kg	LOADCELL ESIT-ZEMIC
AGGREGATE LOADING BELT	1000x13000	7.5 kW
COMPRESSOR	1100 LT/DK 300 LT WITH TANK	11 kW
CONTROL CABINET	NURIS	INSULATED
AUTOMATION	MACRO AUTOMATION	SIMENS



# ASURMAK MCP-100 M3



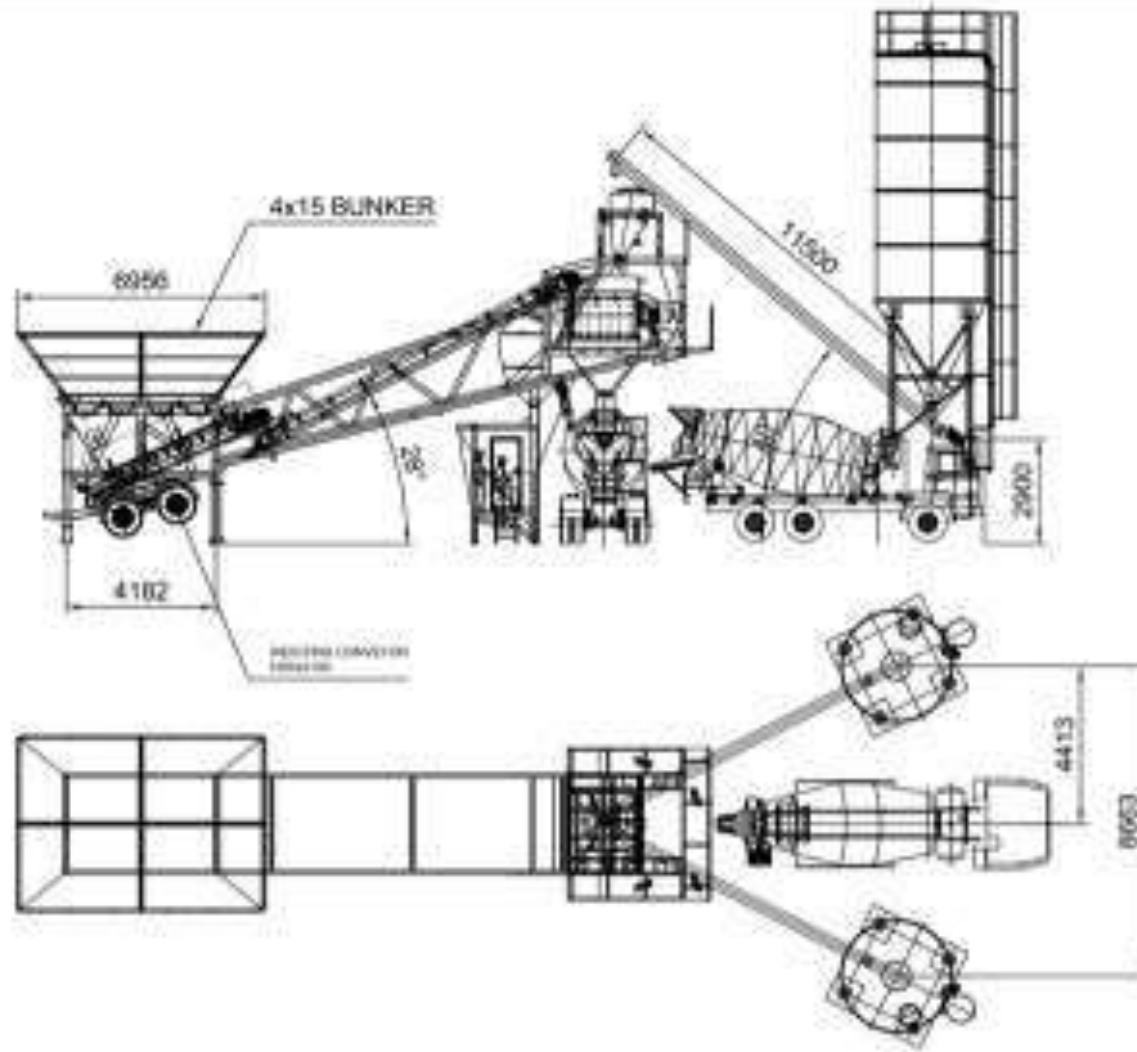

TOPLAM AĞIRLIK: 7600 KG

100 TON ÇİMENTO SİLOSU (KAYNAKLI)

UZUNLUK : 14300 mm  
YÜKSEKLİK : 3372 mm  
GENİRLİK : 3150 mm

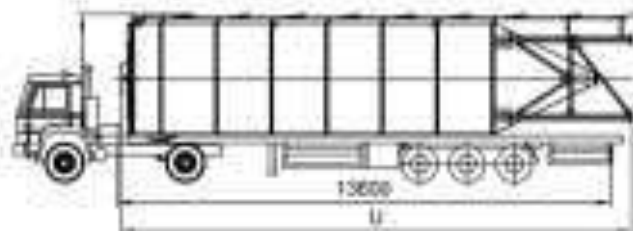

TOPLAM AĞIRLIK: 23000 KG

100 MOBİL BETON SANTRALI

UZUNLUK : 18750 mm  
YÜKSEKLİK : 4450 mm  
GENİRLİK : 3162 mm

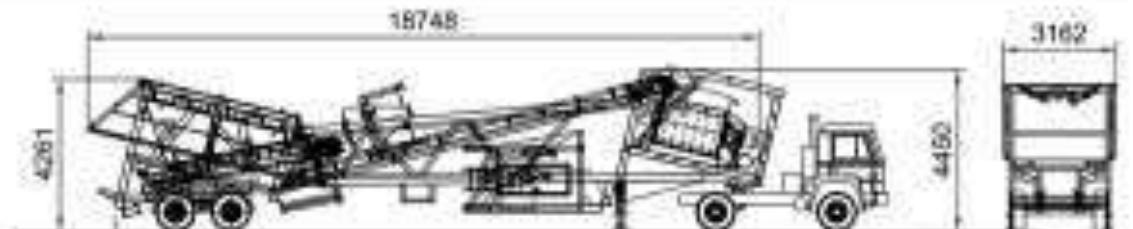

ASMOB 100 m <sup>3</sup> / saat MOBİL BETON SANTRALİ	
TEKNİK ÖZELLİKLERİ	DEĞER - BİRİM
Agrega Bunkeri	4 x 25 = 100 m <sup>3</sup>
Agrega Tartım Bunkeri	5500 kg
Mikser	2 m <sup>3</sup> Tek Milli - Çift Milli
Çimento helazonu	273 x 10,000 mm
Silo Ekipmanları	Silotopt Filtre, Emniyet Valfi, Seviye Göstergesi, Hava Jeti
Çimento Tartım Bunkeri	1000 Kg
Su Tartım Bunkeri	550 Kg
Katkı Bunkeri	30 Kg
Agrega Yükleme Bandı	1,000 x 18,500 mm
Hidrolik Güç Grubu	1,500 lt/dk
Dikey Pano Touch Panel Kontrol Otomasyon	1,500 x 2,250 mm
	TEKNO - SIMENS (SALT)

ASMOB 100 m <sup>3</sup> / h MOBILE CONCRETE PLANTS	
TECHNICAL SPECIFICATIONS	VALUE - UNIT
Aggregate Bunker	4 x 25 = 100 m <sup>3</sup>
Aggregate Weighing Bunker	5500 kg
Mixer	2 m <sup>3</sup> Single Shaft- Twin Shaft
Cement helix	273 x 10,000 mm
Silo equipments	Silotopt Filter, Safety Valve, Level Indicator, Air Jet
Cement Weighing Bunkers	1000 Kg
Water Weighing Bunkers	550 Kg
Contribution Bunker	30 Kg
Aggregate Loading Band	1,000 x 18,500 mm
Hydraulic power group	1,500 lt/min
Vertical panel touch panel controller	1,500 x 2,250 mm
Automation	TEKNO - SIMENS ( SALT )

ASMOB 100 m <sup>3</sup> /ч Мобильная бетонная станция	
ТЕХНИЧЕСКИЕ ОСОБЕННОСТИ	ЦЕНА-СТОИМОСТЬ
Бункер агрегата	4 x 25 = 100 m <sup>3</sup>
Конвейерные весы агрегата	5500 килограмм
Миксер	2 m <sup>3</sup> Одна шпиндель - Два шпиндель
Винтовой конвейер для цемента	273 x 10,000 mm
Аппаратуры силоса	Фильтр силосов, воздушная струя, Указатель уровня, предохранительный клапан,
Бункер взвешивания цемента	1000 килограмм
Бункер взвешивания воды	550 килограмм
Бункер аддитива	30 килограмм
Лента для погрузки агрегата	1,000 x 18,500 mm
Гидравлическая силовая группа	1,500 л/мин
Вертикальная доска сенсорная панель управления	1,500 x 2,250 mm
Автоматизация	Техно - SIMENS (абсолютный)



# ASURMAK MCP-120 M3



ASMOB 120 m <sup>3</sup> / saat MOBİL BETON SANTRALİ	
TEKNİK ÖZELLİKLERİ	DEĞER - BİRİM
Agrega Bunkeri	4 x 30 = 120 m <sup>3</sup>
Agrega Tartım Bandı	1000 x 19000 Bantsan
Mikser	3 m <sup>3</sup> Çift Milli
Çimento helazonu	273 x 11500 mm
Silo Ekipmanları	Silotop Filtre, Emniyet Valfi, Seviye Göstergesi, Hava Jeti
Çimento Tartım Bunkeri	1750 Kg
Su Tartım Bunkeri	750 Kg
Katkı Bunkeri	50 Kg
Agrega Tarnsfer Bandı	1000x13500 mm
Hidrolik Güç Grubu	1880 lt/dk
Dikey Pano Touch Panel Kontrol Otomasyon	NURİŞ Yalıtımlı - Isolated TEKNO - SIMENS ( SALT )

ASMOB 120 m <sup>3</sup> / h MOBİLE CONCRETE PLANTS	
TECHNICAL SPECIFICATIONS	VALUE - UNIT
Aggregate Bunker	4 x 30 = 120 m <sup>3</sup>
Aggregate Weighing Bunker	1000 x 19000 Bantsan
Mixer	3 m <sup>3</sup> Twin Shaft
Cement helix	273 x 11500 mm
Silo equipments	Silotop Filter, Safety Valve, Level Indicator, Air Jet
Cement Weighing Bunkers	1750 Kg
Water Weighing Bunkers	750 Kg
Contribution Bunker	50 Kg
Aggregate Loading Band	1000 x 13500 mm
Hydraulic power group	1880 lt/dk
Vertical panel touch panel controller	Nuriş Insulated - Isolated
Automation	TEKNO - SIMENS ( SALT )

ASMOB 120 m <sup>3</sup> /ч Мобильная бетонная станция	
ТЕХНИЧЕСКИЕ ОСОБЕННОСТИ	ЦЕНА-СТОИМОСТЬ
Бункер агрегата	4 x 30 = 120 m <sup>3</sup>
Конвейерные весы агрегата	1000 x 19000 Bantsan
Миксер	3 m <sup>3</sup> Два шпиндель
Витговой конвейер для цемента	273 x 11500 mm
Аппаратуры силоса	Фильтр силотоп, воздушная струя. Указатель уронци, предохранительный клапан,
Бункер взвешивания цемента	1750 килограмм
Бункер взвешивания воды	750 килограмм
Бункер аддитива	50 килограмм
Лента для погрузки агрегата	1000 x 13500 mm
Гидравлическая силовая группа	1880 л/мин
Вертикальная доска сенсорная панель управления	NURİŞ изолированно
Автоматизация	Техно - SIMENS (абсолютный)

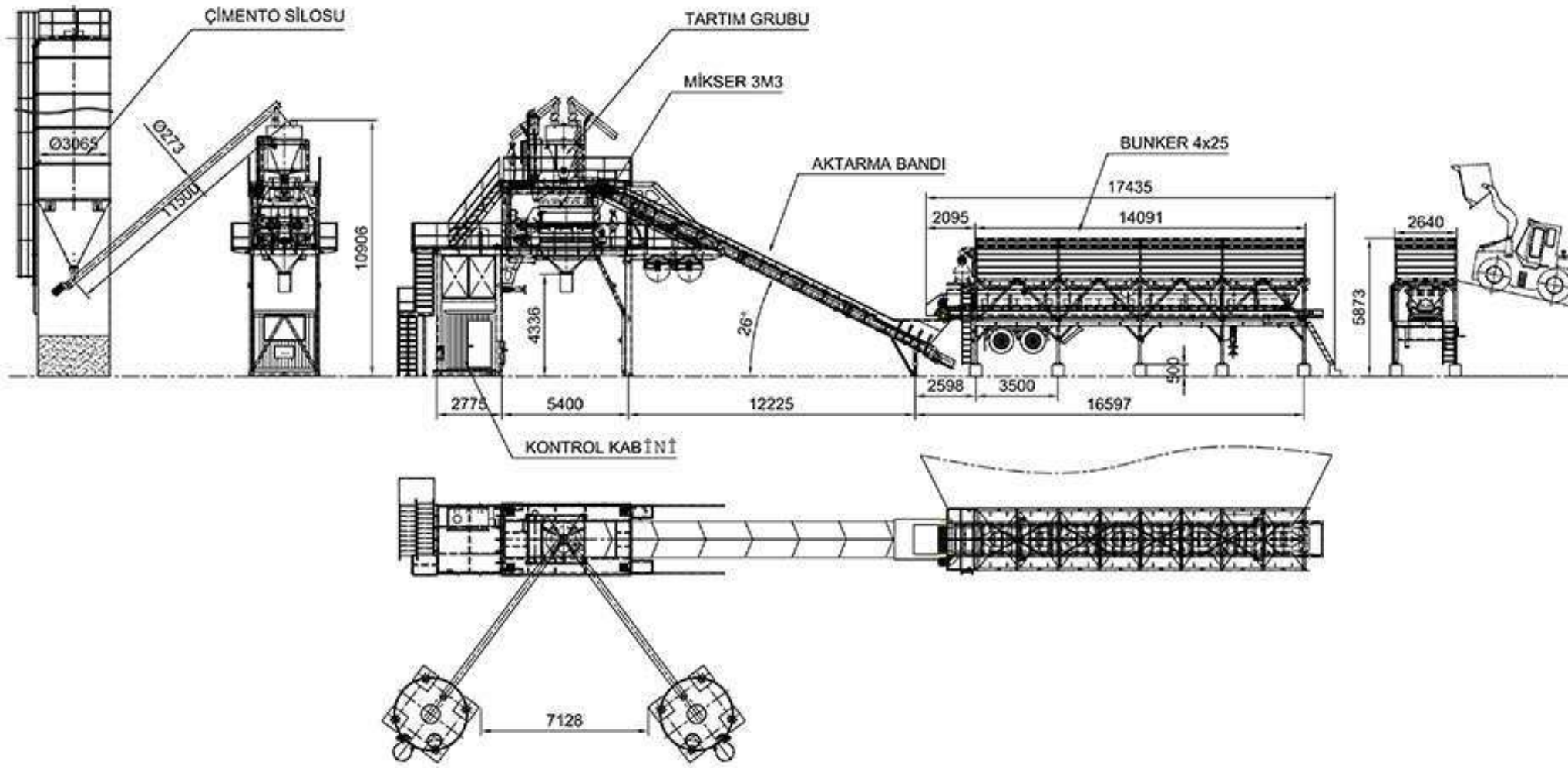

TOPLAM AĞIRLIK: 7900 KG
100 TON ÇİMENTO SİLOSU (KAYNAKLI)
UZUNLUK : 14300 mm
YÜKSEKLİK: 3372 mm
GENİŞLİK : 3150 mm

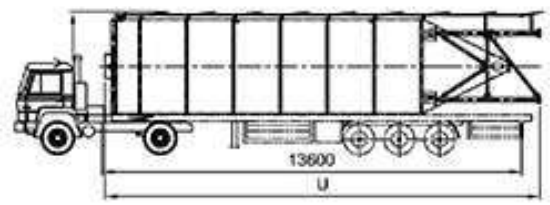

TOPLAM AĞIRLIK: 24000 KG
4x30 MOBİL BUNKER
UZUNLUK : 16909 mm
YÜKSEKLİK: 4250 mm
GENİŞLİK : 2700 mm

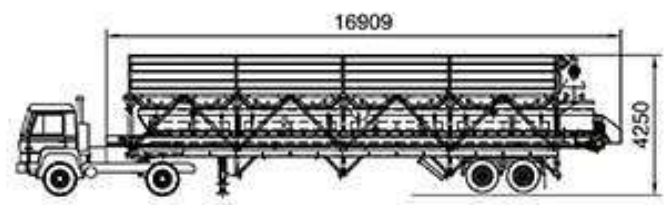

TOPLAM AĞIRLIK: 35000 KG
100 TON ÇİMENTO SİLOSU (KAYNAKLI)
UZUNLUK : 16300 mm
YÜKSEKLİK: 4424 mm
GENİŞLİK : 3100 mm

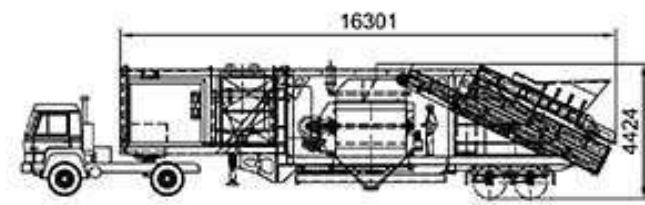

## Ready-Mixed Concrete Production With High Performance

The compact concrete batching plant, which is used to produce ready-mixed concrete with very high performance in narrow working spaces, produces concrete comfortably thanks to the stairs moving upwards. The compact concrete batching plant, which produces 35 and 60 m<sup>3</sup> of concrete per hour according to the needs of the enterprises, has an easy installation and transportation feature.

The compact concrete batching plant, designed by Asur Makina engineers within the scope of European Union standards, has a feature that becomes ready for use in a short time. The environmentally friendly compact concrete batching plant can be used safely in all areas with its feature of not being harmful to people's health. It also adapts to harsh natural conditions.

The compact concrete batching plant, which is produced by the experience and quality of our company, which is in the leading position in the sector, has all kinds of features needed for long-term use. Compact concrete batching plant, which is frequently preferred by companies established with low and medium budgets due to its low cost establishment, has easy assembly and disassembly features.

## Durable Machine, Quality Service

The compact concrete batching plant, which is the most demanded product in recent times, stands out with its low cost and easy installation features. Although it has a smaller structure compared to other products, it does not lose efficiency and power. The compact concrete batching plant, which can fit in the low-cost container, also minimizes transportation costs. The compact concrete batching plant, which is the ideal product for narrow working areas, provides quality services with its powerful performance.

The compact concrete batching plant, which is resistant to harsh working conditions, is a product suitable for long-term use. The compact concrete batching plant, which draws attention with its performance even in narrow spaces, easily adapts to all-terrain conditions. The compact concrete batching plant, designed to operate anywhere in the world without sacrificing quality, can be used by a single operator. The quality of the production is kept at the best level with the computer system. The compact concrete batching plant, which is resistant to wear, enables companies to profit thanks to its low maintenance costs. The compact concrete batching plant, which uses the most advanced technology in concrete production, is ideal for quality and long-term use.

A compact concrete batching plant, using the most advanced technology in concrete production, is ideal for quality and long-term use...

# ASURMAK C 35-M3





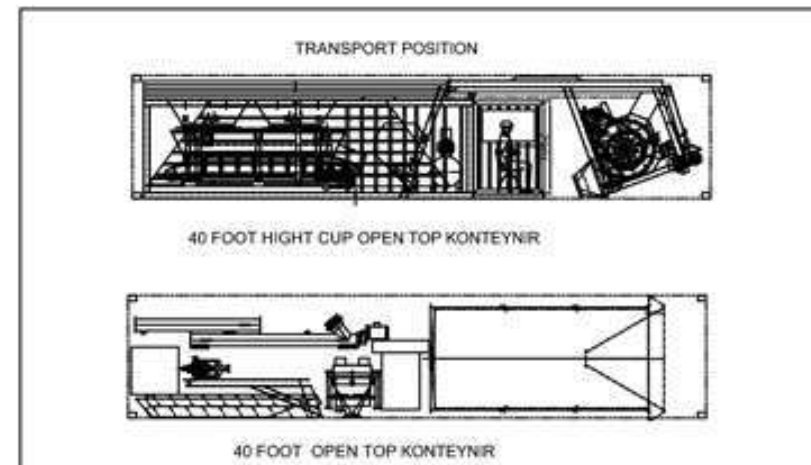
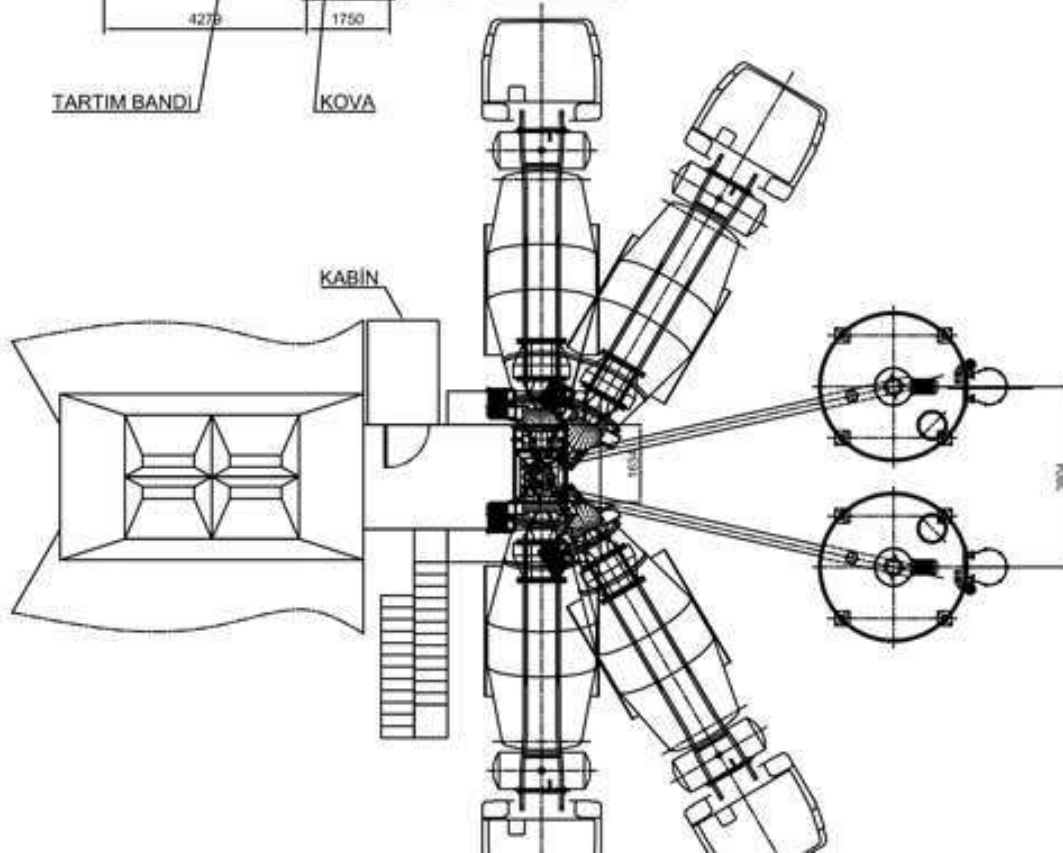
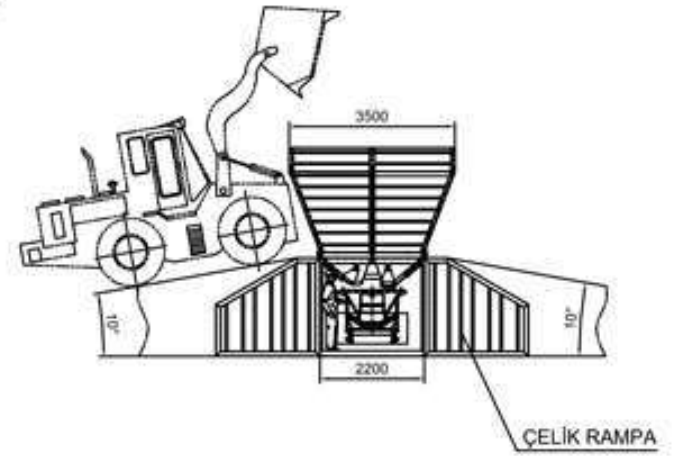
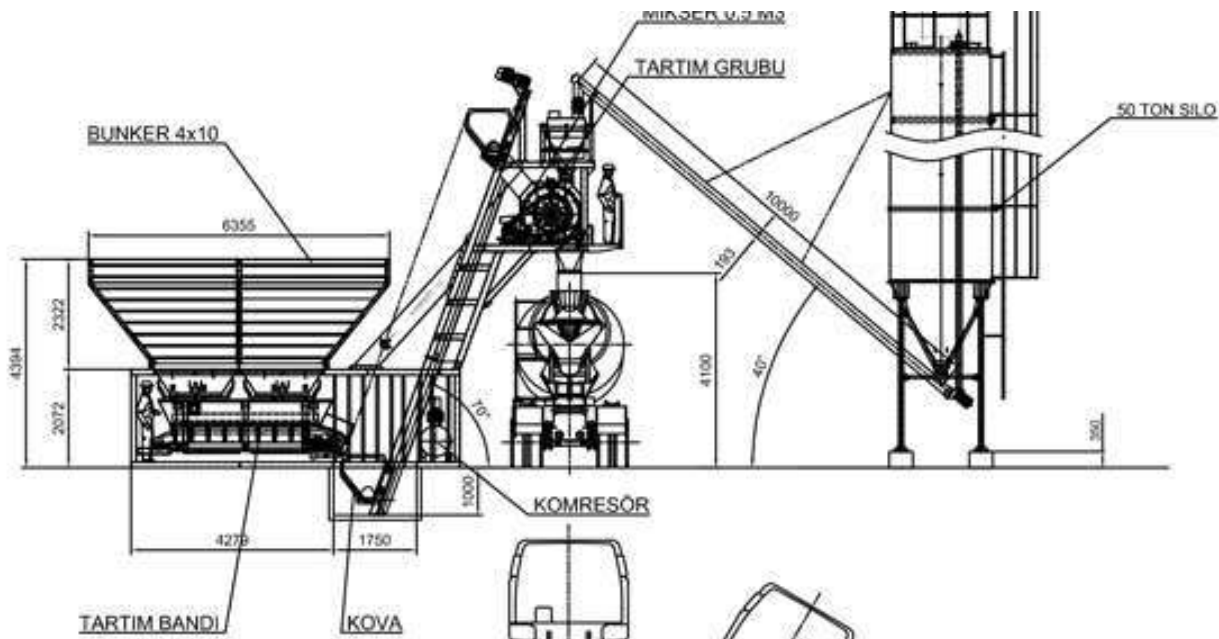

## 35 m3/h KOMPAKT BETON SANTRALİ TEKNİK ÖZELLİKLER

AGGREGATE BUNKER	4x 10=40 m3	
CEMENT SILO	50 Tons	1 PCS
SPIRAL	193x10000	WAM-OTS
SILO EQUIPMENTS !	Silotop Filter, Safety Valve, Level Display. Air Jet	WAM-OTS
CEMENT TART IM BUNKER	250 Kg	LOADCELL ESIT-ZEMIC
WATER TART IM BUNKER	125 Kg	LOADCELL ESIT-ZEMIC
ADDITIVE BUNKER	20 Kg	LOADCELL ESIT-ZEMIC
AGGREGATE WEIGH BAND	800x3000	5.5 kW
AQUARIUS	1250 Kg 04 m/s	5.5 kW
CONTROL CABINET	OPAL-AIR CONDITIONED	INSULATED
AUTOMATION	TECHNO	SIMENS



# ASURMAK C 60-M3



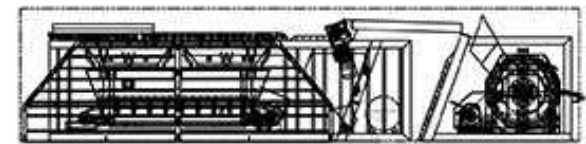
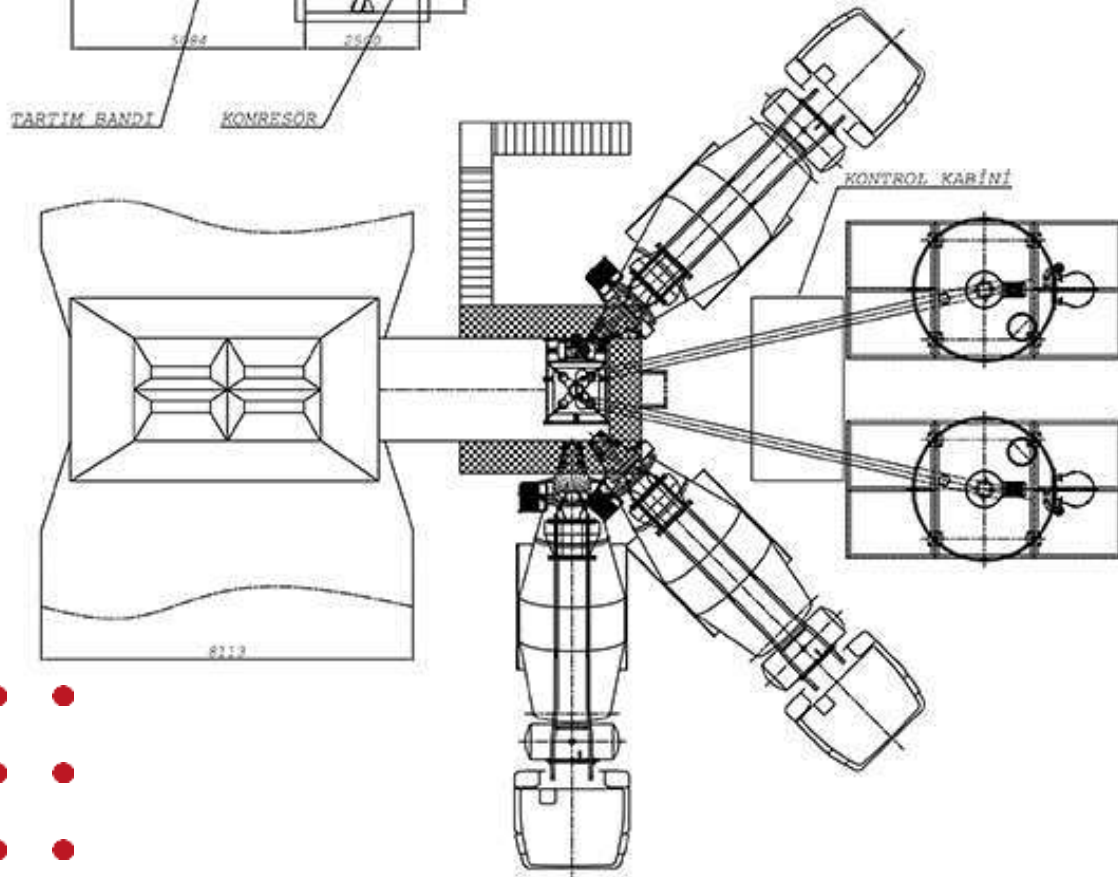
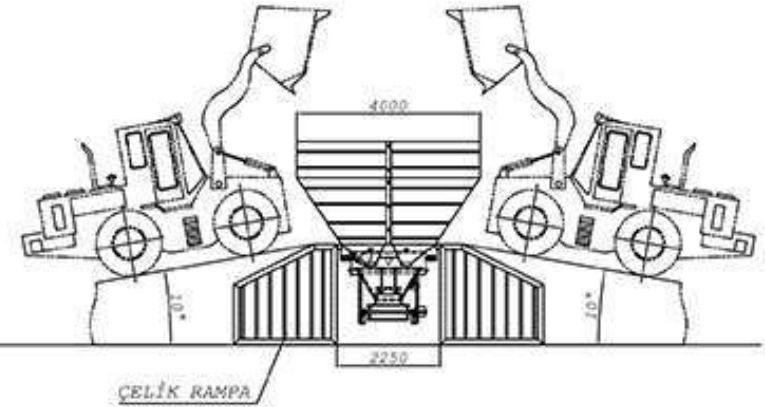
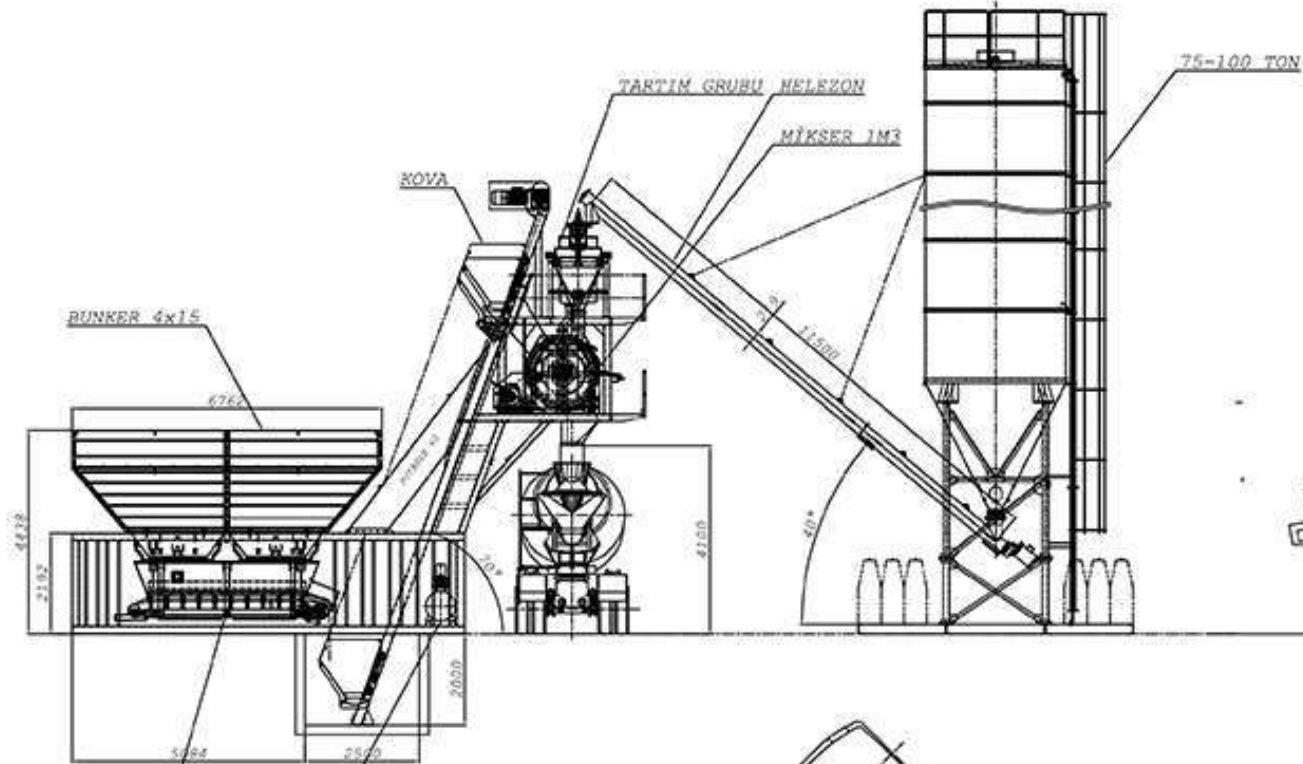

40 FOOT HIGH CUPE OPEN TOP KONYEYİR



40 FOOT OPEN TOP KONYEYİR

## 60 m<sup>3</sup>/h COMPACT CONCRETE PLANT TECHNICAL SPECIFICATIONS

AGR EGA BUNKER	4x 12.5=50 m <sup>3</sup>	
CEMENT SILO	75-100 Tons	1 PCS MEAT
SPIRAL	219x 11500	WAM-OTS
SILO EQUIPMENTS !	Silotop Filter, Safety Valve, Level Display. Air Jet	WAM-OTS
CEMENT TART IM BUNKER	500 Kg	LOADCELL ESIT-ZEMIC
WATER WEIGHING BUNKER	250 Kg	LOADCELL ESIT-ZEMIC
ADDITIVE BUNKER	20 Kg	LOADCELL ESIT-ZEMIC
AGR EGA TART I BAND	800x4000	7.5 kW
AQUARIUS	2250 Kg 04 m/s	11 kW
CONTROL CABINET	OPAL-AIR CONDITIONED	INSULATED
AUTOMATION	TECHNO	SIMENS



Our company, which produces long-lasting, high quality and durable domestic mixers, is the leading company in the sector with domestic mixer production in mixers, which are the most important equipment of the concrete plant. It responds to every need with different domestic mixer productions according to the project in which the concretes will be used, and makes a name for itself in the sector with its durable mixer types produced from first-quality casting materials.

#### Domestic Mixer Types

- Single-shaft mixer
- Double-shaft mixer
- Pan mixer
- Planetary mixer

Our domestic mixer types are mixers that meet different needs in terms of capacity, each with its own characteristics. Single shaft mixers have a capacity of 0.5 m<sup>3</sup>, 1 m<sup>3</sup>, 2 m<sup>3</sup>,

- Our double shaft mixers have 1 m<sup>3</sup>, 2 m<sup>3</sup>, 3 m<sup>3</sup>, 4 m<sup>3</sup>, and 5 m<sup>3</sup> capacities
- Our pan mixers have a first-quality 5 m<sup>3</sup>, 1 m<sup>3</sup>, 2 m<sup>3</sup>, 3 m<sup>3</sup> and
- Our planetary mangle-shaft capacity Double-shaft m<sup>3</sup>, 2 m<sup>3</sup>.

#### *Native Mixer Specifications*

Our domestic mixers are easy to use and long-lasting with their robust spiral mixing arms and compact structure. With its practical loading function, it does its part to complete the most difficult projects as soon as possible, and sets itself apart from its competitors with its high technical features.

Our company, which always provides customer satisfaction by offering the highest quality service at the most affordable prices with its professional staff and years of experience, has succeeded in taking the place it deserves in the sector by working without sacrificing quality. You will find all the mixer models you are looking for in domestic mixer types that mix the concrete homogeneously according to their capacities and provide the highest efficiency with the lowest cost.

#### **Design Wonders Domestic Mixers**

You will find all the models you are looking for in the domestic mixer types that are perfect in terms of materials, production, workmanship, and design and meet every need. You will always be pleased to work with our company for the best quality domestic mixer models in the sector at the most economical prices for maximum efficiency with minimum cost. You can use our website to contact our company, which is always behind its products, and to have one of the domestic mixer types you need, and you can reach us from the contact information. Our company, which closely follows the developing technology and responds to your needs with the latest model designs, is proud of providing the highest quality service at the most economical prices.

# SINGLE SHAFT MIXER

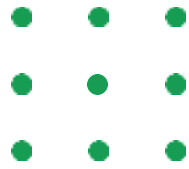

0,5 m<sup>3</sup>, 1 m<sup>3</sup>, 2 m<sup>3</sup> capacity mixers are produced.

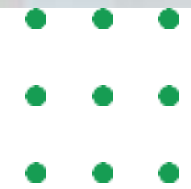
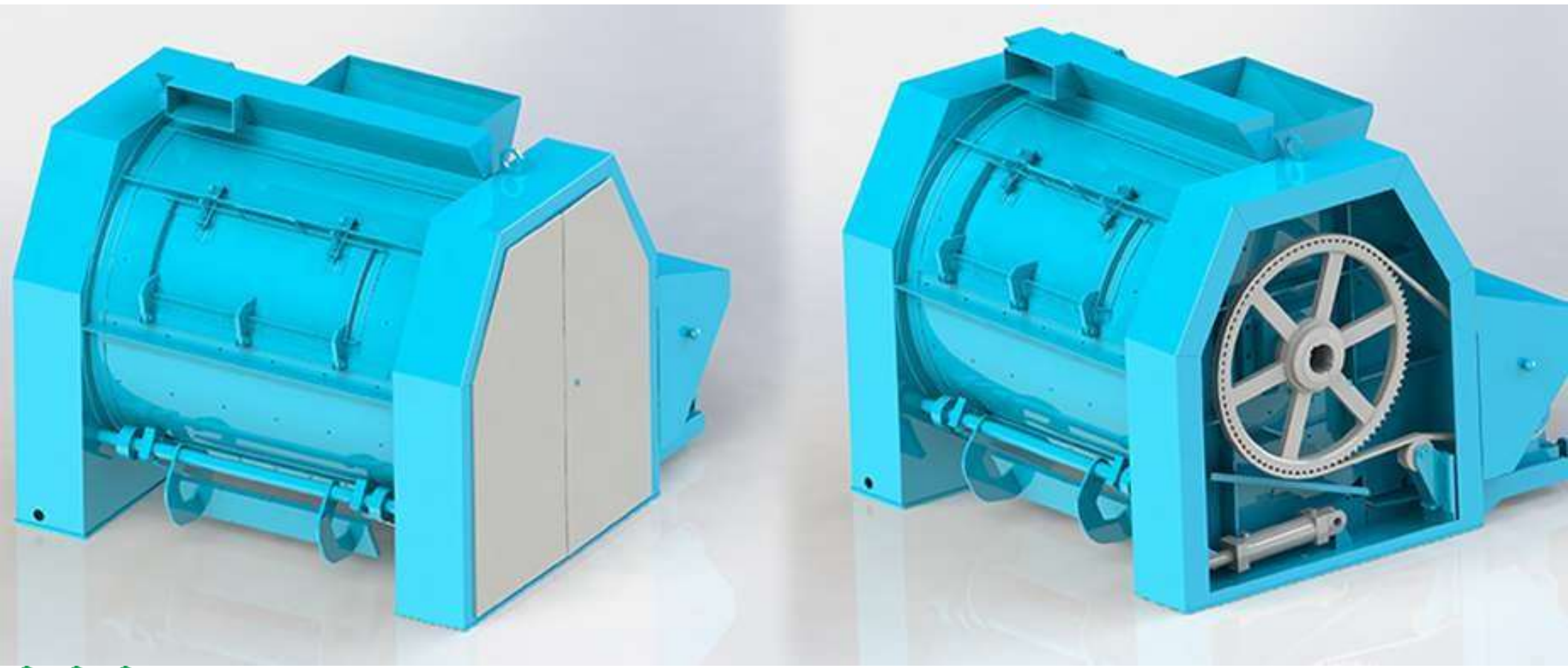

ASMİX 0,5 m <sup>3</sup> / saat TEK MİLLİ MİKSER	
TEKNİK ÖZELLİKLERİ	DEĞER-BİRİM
Tip	Tek Milli
Kapasitesi	0,5 m <sup>3</sup>
Kuru Yükleme Kapasitesi	750 lt
Taze Beton Kapasitesi	625 lt
Sıkıştırılmış beton kapasitesi	500 lt
Motor redüktör	18,5 kW
Boşaltma kapağı	Hidrolik
Boşaltma kapak Adedi	1 Adet
Merkezi Yağlama	SKF
Maximum Karıştırma Tane büyüklüğü	90 mm
Karıştırıcı Palet	32(NiHard4) mm
Mikser Gövde Aşınmazı	20(st52) mm

ASMİX 0,5 m <sup>3</sup> / hour SINGLE SHAFT MIXER		
TECHNICAL SPECIFICATIONS	VALUE	UNIT
Tip	Single Shaft	
Capacity	0,5 m <sup>3</sup>	
Dry Loading Capacity	750 lt	
Fresh Concrete Capacity	625 lt	
Compressed concrete capacity	500 lt	
Motor gear unit	18,5 kW	
Unloading lid	Hydraulic	
Unloading lid Piece	1 Piece	
Central Lubrication	SKF	
Maximum Mixing Grain size	90 mm	
Mixer Pallet	32(NiHard4) mm	
Mixer Body not wearing	20(st52) mm	

ASMİX 0,5 m <sup>3</sup> /ч МИКСЕР С ОДНОМ ШПИНДЕЛЕМ	
ТЕХНИЧЕСКИЕ ОСОБЕННОСТИ	ЦЕНА-СТОИМОСТЬ
Вид	Одна шпindelь.
Мощность	0,5 m <sup>3</sup>
Мощность для сухой загрузки	750 lt
Мощность свежего бетона	625 lt
Мощность уплотненного бетона	500 lt
Моторредукторы	18,5 кВт
Сливная крышка	Гидравлика
Штук сливной крышки	1 Штук
Централизованная смазка	SKF
Размер гранул для максимума смешения	90 mm
Смешивающее устройство	32(NiHard4) mm
Коррозионно-стойкие корпус миксера	20(st52) mm





# DOUBLE SHAFT MIXER

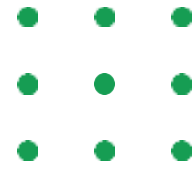

1 m<sup>3</sup>, 2 m<sup>3</sup>, 3 m<sup>3</sup>, 4 m<sup>3</sup>, 5 m<sup>3</sup> capacity mixers are produced.

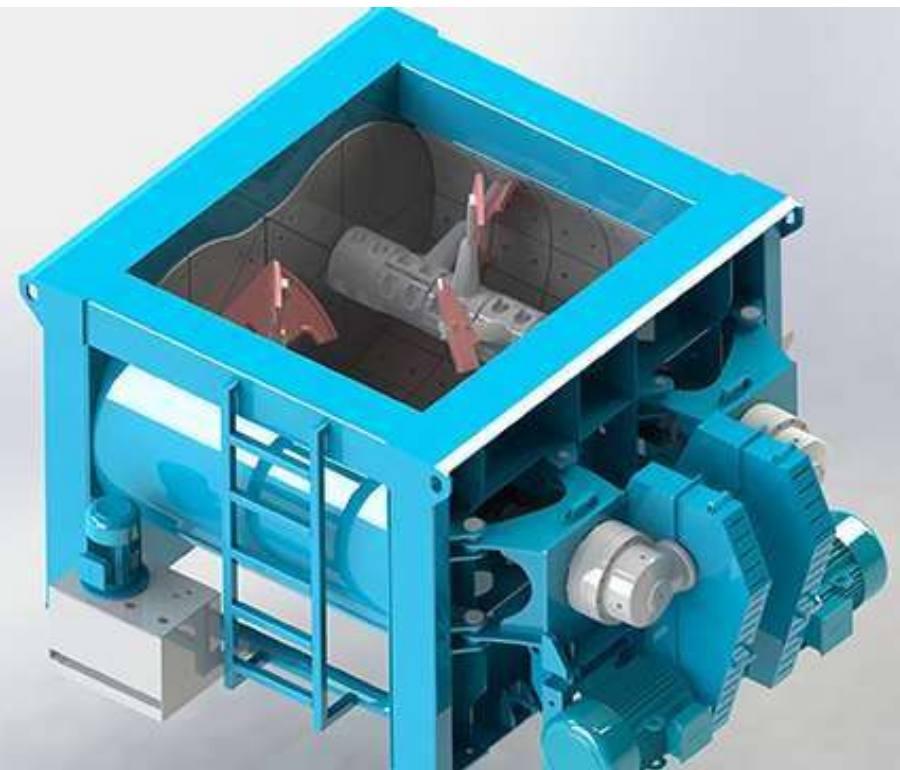
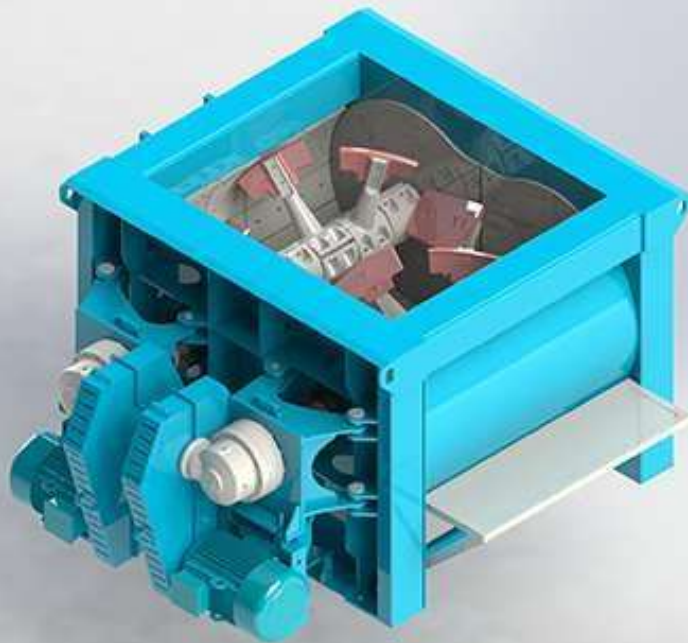

# PAN MIXER

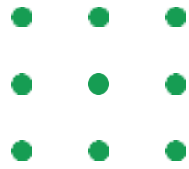

0,5 m<sup>3</sup>, 1 m<sup>3</sup>, 2 m<sup>3</sup> capacity mixers are produced.

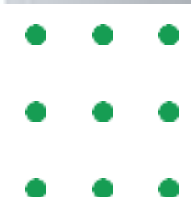

# PLANET MIXER

0,5 m<sup>3</sup>, 1 m<sup>3</sup>, 2 m<sup>3</sup> capacity mixers are produced.

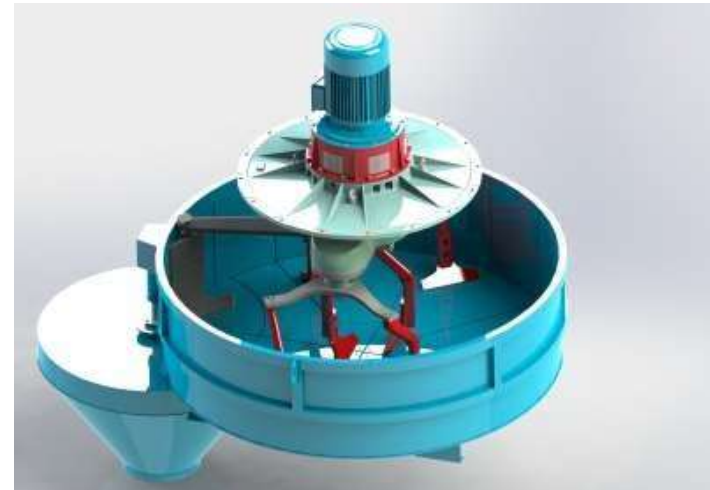
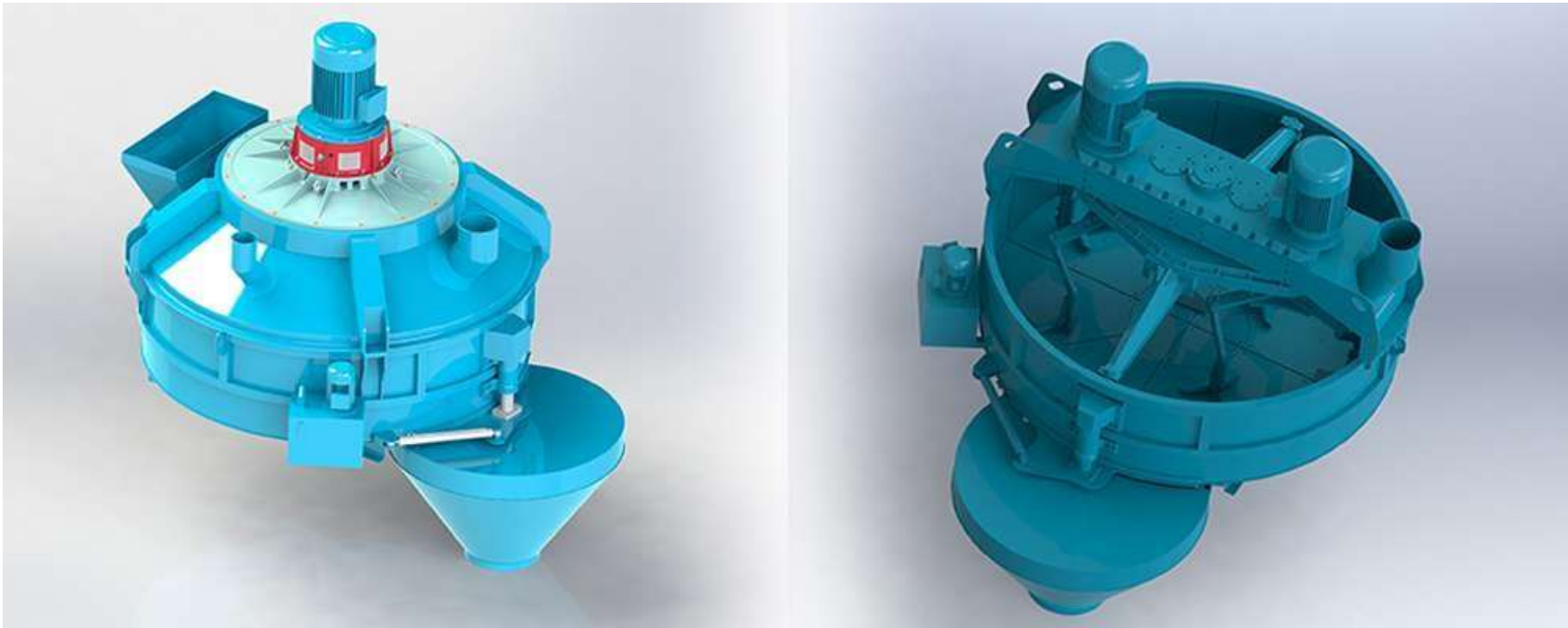

The dry type concrete batching plant, which is produced as mobile and fixed in 60 m<sup>3</sup>, 100 m<sup>3</sup> and 120 m<sup>3</sup> capacities, is produced in accordance with every need with a 30 tons cement silo and cement and water weighing bunkers of different capacities. The most distinctive feature of the dry type concrete batching plant is the absence of a concrete mixer, unlike other concrete batching plants. Mixing of water, cement and other materials is done by mixer trucks..

Dry Type Concrete Batching Plants are produced as mobile and fixed at a capacity of 60 m<sup>3</sup> - 100 m<sup>3</sup> -120 m<sup>3</sup>.

## Dry Type Concrete Plant Working System

Aggregate, cement and water are automatically weighed and discharged directly to the mixer truck. Since there is no mixer in the dry type concrete plant, the mixing process is carried out on trucks. Our company, which provides a quality service with its high-tech equipment, is a reliable and competent company that always provides customer satisfaction. It is the leading company of the sector in the production of dry type concrete batching plants with its production under warranty, 24/7 service and spare parts production..

## Advantages of Dry Type Concrete Batching Plant

Dry type concrete batching plant, which is one of the most affordable concrete batching plants, is advantageous with its low transportation costs and low costs. For this reason, it ranks first among the most preferred concrete batching plants..

- The mixing process is done in the mixer truck, not in the mixer tank, water, cement and additives are automatically weighed and the process is completed.
- Dry type concrete batching plant is installed and delivered in a short time.
- It is easy to use and practical.
- Concrete cost for installation is minimal.
- It is the most preferred concrete batching plant type by dam and construction companies.

## Dry Type Concrete Batching Plant in Concrete Usage

Today, the use of concrete has increased considerably due to the construction of high-rise buildings and the production of many concrete equipment. Considering the increase in costs and labor, it is obvious how high the total costs are. With its easy installation, low cost and functionality, dry type concrete batching plants are among the first choices as portable concrete batching plants. Our company, which produces dry type concrete batching plants with different capacities and features, has always been focused on customer satisfaction by offering the best quality service in the sector at the most affordable prices since 2012. It is the right address for dry type concrete batching plant supply with its expert staff, high quality and state-of-the-art production and economical prices..

## KURU TİP MOBİL BETON SANTRALI TEKNİK ÖZELLİKLER

AGGREGATE BUNKER	3x25=75 m3	SORT TYPE
CEMENT SILO	30 Tons	1 PIECE ON CHASSIS
SPIRAL	193-219-273	WAM-OTS
SILO EQUIPMENT	Silotop Filter, Safety Valve, Level Display. Air Jet	WAM-OTS
CEMENT WEIGHING BUNKER	500-1000-1750	LOADCELL ESIT-ZEMIC
WATER WEIGHING BUNKER	200-400-750	LOADCELL ESIT-ZEMIC
ADDITIVE BUNKER	20-50	LOADCELL ESIT-ZEMIC
AGGREGATE WEIGHING BAND	600-800-1000	7.5KW-11KW-15KW
TRANSFER BELT	600-800-1000	7.5KW-11KW-15KW
CONTROL CABINET	OPAL-AIR CONDITIONED	INSULATED
AUTOMATION	TECHNO	SIMENS





Imported mixers offered by Asur Makina as double shaft are imported with a capacity of 1 m<sup>3</sup>, 2 m<sup>3</sup>, 3 m<sup>3</sup>, 4 m<sup>3</sup> and 5 m<sup>3</sup>. Imported mixers used in the production of ready-mixed concrete are included in the projects for concrete production.

Imported Mixers are imported as double shaft with a capacity of 1 m<sup>3</sup>, 2 m<sup>3</sup>, 3 m<sup>3</sup>, 4 m<sup>3</sup>, 5 m<sup>3</sup>..

## Imported Mixers and Features

Imported mixers, which have a consistency that can be prepared at lower water and humidity ratios, have a superior performance in concrete production. Asur Makina, which is more preferred in applications with very long mixing times, ensures that more homogeneous concrete is obtained in a much shorter time with the effect of rotation of the mixing arms of imported mixers both around its own axis and around the boiler..

Imported mixers, which are extremely easy to repair and maintain, provide long-term use with their quality structure. Our imported mixers, which have a capacity of 1 - 2 - 3 m<sup>3</sup>, have a dry loading capacity of 1500 - 3000 - 4500 liters. The fresh concrete capacity of our product is 1250 - 2500 - 3750 liters. The compressed concrete capacity of imported mixers is 1000 - 2000 - 3000 liters..

The discharge cover of imported mixers with a maximum mixing grain size of 90 mm is hydraulic. Our imported mixers, which stand out with their compact structure and high technology, are the pioneers in the sector in the production of quality concrete..

Why Asur Makina Imported Mixers should be preferred?

Imported mixers with robust mixing arms offer a quick mixing opportunity with their compact structure. The demand for the product, which is easy to operate with its practical loading feature, is increasing day by day due to its long life and high quality.

With Asur Makina imported mixers, it is possible to convert a dry type concrete batching plant into a wet type concrete batching plant without making almost any changes in the existing structure. With the addition of easy transportation and fast installation features, the advantages of imported mixers have increased.

Imported mixers, which enable high quality concrete design, also provide production flexibility. In order to meet all the needs of our customers in the best way, different capacity options are offered. Imported mixers with high reliability and efficiency have low maintenance and operating costs. Therefore, it is much more advantageous than other mixers. To take advantage of these advantages, you can get all kinds of information by contacting us.

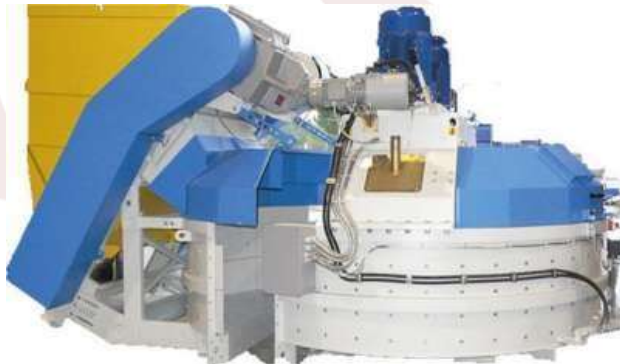



**ASMIX 1-2-3 m<sup>3</sup> / saat ÇİFT MİLLİ MİKSER**  
**ASMIX 1-2-3 m<sup>3</sup> / hour TWIN SHAFT MIXERS**  
**ASMIX 1-2-3 м<sup>3</sup>/ Час МИКСЕРЫ С ДВУХ ШПИНДЕЛЯХ**

<b>TEKNİK ÖZELLİKLERİ</b> <b>TECHNICAL SPECIFICATIONS</b> <b>ТЕХНИЧЕСКИЕ ОСОБЕННОСТИ</b>	<b>DEĞER - BİRİM</b> <b>VALUE - UNIT</b> <b>ЦЕНА-СТОИМОСТЬ</b>
<b>Tip - Вид</b>	Çift Millî - Twin Shaft Два шпиндель
<b>Kapasitesi - Capacity - Мощность</b>	1 - 2 - 3 m <sup>3</sup>
<b>Kuru Yükleme Kapasitesi - Dry Loading Capacity</b> <b>Мощность для сухой загрузки</b>	1500-3000-4500 lt
<b>Taze Beton Kapasitesi - Fresh Concrete Capacity</b> <b>Мощность свежего бетона</b>	1250-2500-3750 lt
<b>Sıkıştırılmış beton kapasitesi - Compressed concrete capacity</b> <b>Мощность уплотненного бетона</b>	1000-2000-3000 lt
<b>Motor redüktör - Motor gear unit - Моторредукторы</b>	2x18,5-2x37-2x55 kw-кВт
<b>Boşaltma kapağı - Unloading lid - Сливная крышка</b>	Hidrolik - Hydraulic Гидравлика
<b>Boşaltma kapak Adedi - Unloading lid Piece</b> <b>Штук сливной крышки</b>	1 Adet - 1 Piece 1 Штук
<b>Merkezi Yağlama - Central Lubrication</b> <b>Централизованная смазка</b>	SKF
<b>Maximum Karıştırma Tane büyüklüğü - Maximum Mixing Grain size</b> <b>Размер гранул для максимума смешения</b>	90 mm
<b>Karıştırıcı Palet - Mixer Pallet - Смешивающее устройство</b>	32(NiHard4) mm
<b>Mikser Gövde Aşınmazı - Mixer Body not wearing</b> <b>Коррозионно-стойкие корпус миксера</b>	20(st52) mm

**ASMIX 1-2-3 m<sup>3</sup> / saat ÇİFT MİLLİ MİKSER**  
**ASMIX 1-2-3 m<sup>3</sup> / hour TWIN SHAFT MIXERS**  
**ASMIX 1-2-3 м<sup>3</sup>/ Час МИКСЕРЫ С ДВУХ ШПИНДЕЛЯХ**

<b>TEKNİK ÖZELLİKLERİ</b> <b>TECHNICAL SPECIFICATIONS</b> <b>ТЕХНИЧЕСКИЕ ОСОБЕННОСТИ</b>	<b>DEĞER - BİRİM</b> <b>VALUE - UNIT</b> <b>ЦЕНА-СТОИМОСТЬ</b>
<b>Tip - Вид</b>	Çift Millî - Twin Shaft Два шпиндель
<b>Kapasitesi - Capacity - Мощность</b>	1 - 2 - 3 m <sup>3</sup>
<b>Kuru Yükleme Kapasitesi - Dry Loading Capacity</b> <b>Мощность для сухой загрузки</b>	1500-3000-4500 lt
<b>Taze Beton Kapasitesi - Fresh Concrete Capacity</b> <b>Мощность свежего бетона</b>	1250-2500-3750 lt
<b>Sıkıştırılmış beton kapasitesi - Compressed concrete capacity</b> <b>Мощность уплотненного бетона</b>	1000-2000-3000 lt
<b>Motor redüktör - Motor gear unit - Моторредукторы</b>	2x18,5-2x37-2x55 kw-кВт
<b>Boşaltma kapağı - Unloading lid - Сливная крышка</b>	Hidrolik - Hydraulic Гидравлика
<b>Boşaltma kapak Adedi - Unloading lid Piece</b> <b>Штук сливной крышки</b>	1 Adet - 1 Piece 1 Штук
<b>Merkezi Yağlama - Central Lubrication</b> <b>Централизованная смазка</b>	SKF
<b>Maximum Karıştırma Tane büyüklüğü - Maximum Mixing Grain size</b> <b>Размер гранул для максимума смешения</b>	90 mm
<b>Karıştırıcı Palet - Mixer Pallet - Смешивающее устройство</b>	32(NiHard4) mm
<b>Mikser Gövde Aşınmazı - Mixer Body not wearing</b> <b>Коррозионно-стойкие корпус миксера</b>	20(st52) mm



## What Does Recycling Unit Mean?

In general, the system that is recycled for reuse by separating the aggregate size and wastewater of the concrete remaining in the trans mixers and to be discarded due to faulty production or prescription is called the recycling unit. Today, the importance given to environmental responsibility has increased. In order to leave a more beautiful and cleaner world to future generations, standards have been introduced with a special rule for concrete production.

Attaching great importance to the environment, Asur Makina helps you, our valued customers, by producing recycling solutions as well as concrete batching plants. Businesses that have recycling facilities can use all of the aggregate and water from the remaining waste concrete in re-production. Although this amount per vehicle seems low, great savings are achieved in the long run..

The capacity of our recycling unit is 10 m<sup>3</sup> per hour. The maximum aggregate particle size is 50 mm. While the total motor power of our unit is 11 kW, its operating voltage is 380 V / 50 hz. While our system protects the environment, it also provides a cost advantage with its recycled concrete components.

## Recycling Unit Advantages

The recycling unit produced by Asur Makina helps many companies with the advantages it provides. Thanks to the recycling unit that can be installed next to the concrete plants, the necessity of transporting the waste concrete to another area is eliminated and this saves transportation costs.

The recycling unit, which has a low operating time, provides cost advantages with less energy and water consumption. Our unit, which has an easy and fast maintenance feature, offers low cost advantage to businesses. It provides long-term use with its wear-resistant feature. Aggregate, which is recovered after the waste concrete is washed in the recycling unit and then separated into its components, can be reused in concrete production at certain rates. In addition, the sedimentation of the cement particles in the cementitious water taken from the washing unit is not allowed with the help of the agitator and it is provided to be used in the concrete plant again. This provides significant savings.

DUE to the recycling unit system we have established, the recovery is spread over the working time on a daily basis. In this case, an immediate solution can be provided without leaving the job to the end. You can contact us to have a recycling unit with high efficiency in solid or liquid separation.





<b>TEKNİK ÖZELLİKLERİ</b> <b>TECHNICAL SPECIFICATIONS</b> <b>ТЕХНИЧЕСКИЕ ОСОБЕННОСТИ</b>	<b>DEĞER - BİRİM</b> <b>VALUE - UNIT</b> <b>ЦЕНА-СТОИМОСТЬ</b>
<b>Kapasitesi - Capacity - Capacité</b>	<b>10 m<sup>3</sup> Saat / hour / Час</b>
<b>Maximum Agregat Tane Büyüklüğü-Maximum Aggregate Grain Size</b> <b>Максимальный размер частиц агрегата</b>	<b>50 mm</b>
<b>Toplam motor gücü-Total engine power - Общая мощность двигателя</b>	<b>11 kW</b>
<b>Çalışma Voltajı - Working Voltage - Рабочее напряжение</b>	<b>380 V / 50 Hz</b>

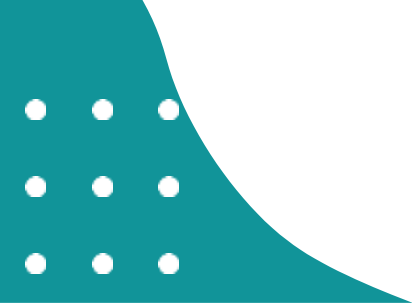

The mobile feedback unit is the production of our company with the advantage of fast installation and immediate efficiency and is offered to customers in different sizes and capacities. With the use of state-of-the-art equipment and quality materials for the mobile feedback unit, you can always call our company and benefit from the equipment that is completely our own production at the most affordable prices..

## **Mobile Feedback Features**

Our company, which makes a production that meets all needs as a mobile feedback unit with a capacity of 400 tons, is the leading company in the sector with its production and workmanship quality. Optional feedback unit is used in mobile concrete batching plants and layout designs are meticulously made by our professional staff. Considering the economy of the construction site or the construction company, the highest quality service is provided with the design and installations made at minimum cost.sunulmaktadır.

## **Mobile Feedback to Portable Concrete Batching Plants**

Ready-mixed concrete producers and construction companies handle project-based concrete works with the selection of portable concrete batching plants. Mobile feedback units have an extremely important functionality with their fast installation and use in smaller areas. In today's time, where time is important, mobile feedback units are at the forefront with their functionality in ready-mixed concrete production. Our company, which is always among the first choices for those who need mobile feedback units to use in long or short-term projects, is the address you are looking for with its economical prices and fast and high quality service understanding. adrestir.

## **Working logic**

With the help of conveyors, the weighed material is conveyed to the mixer and ready-mixed concrete production is completed in a shorter time with mobile feedback units in suitable sizes and capacities. The mobile feedback unit, which is used in the production of new generation ready-mixed concrete and facilitates the work of the sector employees, is a state-of-the-art product with its automatic working mechanism. It can be operated either manually or with a remote control and provides all the comfort for a faultless concrete production.

Our company, which is always among the first choices as a company that closely follows technological developments and uses it in its production, is a company where you will find the mobile feedback units you are looking for at the most affordable prices. Contact us by phone or e-mail on our website, and make the most profitable shopping of your life.





TECHNICAL SPECIFICATION	VALUE-UNIT
Capacity	400 tone/hour
Bunker Reservoir	3m <sup>3</sup> Top Gird
Conveyer	800 X 18500 mm
Engine	22kW
Rotating groove	1.1kW



In order to ensure efficiency and quality under the most suitable conditions, it is necessary to design the Crushing and Screening Plant, to select the machinery and equipment, to design by considering the structural and geological characteristics of the stones to be crushed, and to manufacture and assemble them by experts. Asur Makina, which is competent in this field, helps to eliminate your deficiencies in this field with its Crushing and Screening Plant services..

## **Crushing and Screening Plant Features**

The crushing and screening plant, which is used in the production of crushed stone such as concrete, asphalt and road material in the construction sector, is used in the processing of ores produced in the mining sector. It is important to have the necessary experience and knowledge in order to ensure the cost and quality balance in the production of materials. Asur Makina has proven its quality with the crushing and screening plant services it has been providing since 2012..

The materials extracted from the quarries are subjected to three separate crushing processes. After the crushing processes called primary, secondary and tertiary, all materials are sieved and classified according to the desired dimensions. In this way, the last stage of crushed stone production is completed

The crushing and screening plant, which produces the raw materials needed for use in many sectors by processing stones of different sizes and properties, ensures that the stones obtained from the quarries are processed and then classified according to their usage areas and properties.

All stones with different properties such as limestone, granite and lime can be processed. The most important features and advantages of crushing and screening plants are that they perform both crushing, screening, washing and storage operations under a single establishment. There is no need for a separate facility for all these processes, which are different from each other.

## **Production Stages at the Facility**

The first stage in the crushing and screening plant is the crushing phase. The materials obtained after this process are passed through vibrating sieves. Powdered materials are obtained from large rocks. Our company, which develops different crushing and screening plant solutions according to your different needs, offers the most suitable machines according to the size and hardness of your materials subject to crushing..

The crushing and screening plant, which is designed in the most appropriate way according to your ores to be processed by expert engineers, ensures that even the hardest materials can be easily crushed and processed. All equipment is selected in a quality way and you are given the best crushing and screening facility service. You can contact us to benefit from our quality products.



**It can be produced from 100 tons to 1000 tons.**









# SPARE PART

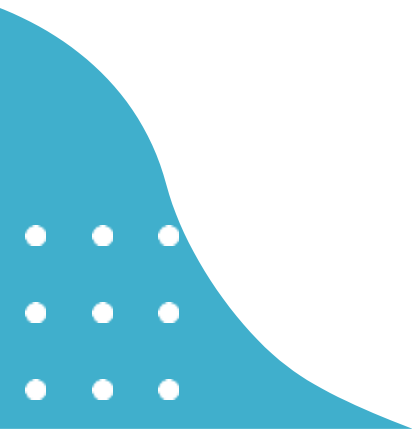
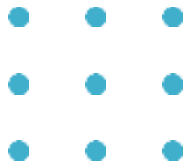

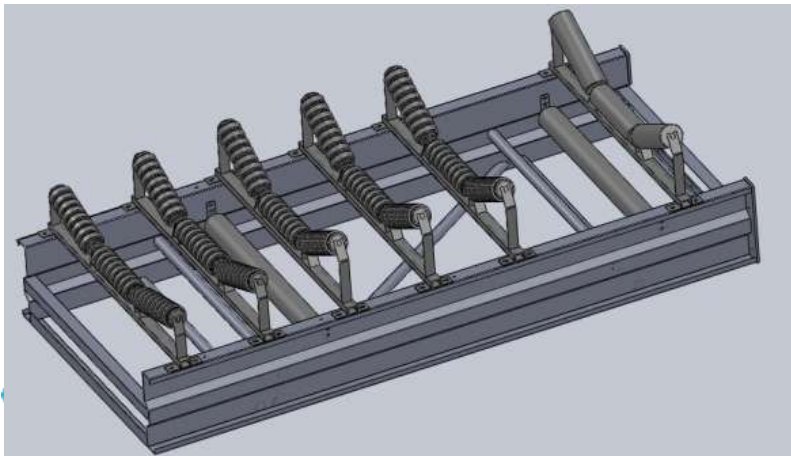

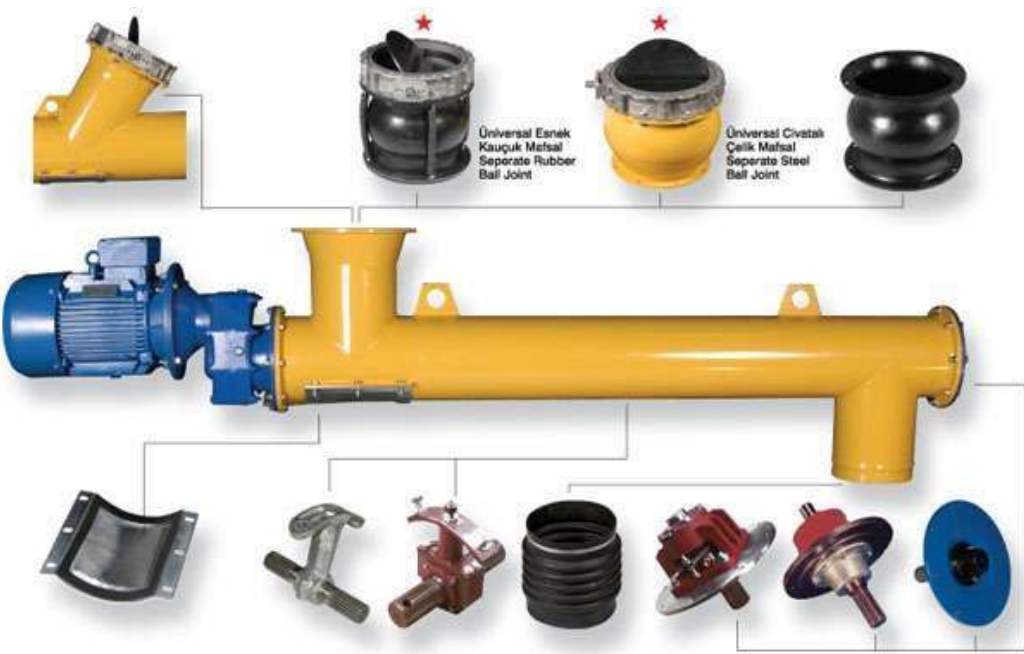



Many points should be considered when purchasing second-hand concrete batching plants. Steps taken without sufficient information can cause great losses for companies. For this reason, if a power plant is to be purchased, the most important point to be considered is to purchase a facility suitable for its working capacity. Facilities operating below the determined production will not meet the expectation. Likewise, a facility above the determined production capacity should not be purchased, in this case an unnecessary cost gap will occur. Since concrete plants can do long-term work, they can be sold to another company after a certain period of operation. Our company, which is an expert in second-hand mobile concrete batching plants, will provide you with the support you need. Firms save a great deal in terms of costs. At the same time, since the necessary maintenance is done to the plant, it can show the same workforce as the zero concrete batching plant.

Concrete batching plants are very strong structures considering their intended use. Concrete batching plant is an indispensable option for companies dealing with both building design and construction. Ready-mixed concrete production meets the market needs of all companies to a large extent. For this reason, these concrete batching plants acquired by companies can be seen as a big investment in the business they carry out. Second-hand concrete plant price is of course also important. Our company appeals to every budget and is economical. Many companies are generally preferred for short-term projects. In this way, the work they carry out is completed and the out-of-pocket budget is reduced to a minimum. At the same time, it is very practical and affordable for companies carrying out mobile projects. At the end of the project, the company owners can resell the concrete batching plant.

Companies requesting a second hand concrete batching plant first reach our company and prepare the layout plan where the plant will be placed. After the layout plan is approved, the employees of the company start the concrete pouring process in accordance with this plan, and the assembly process of the concrete plant is started sequentially. After the assembly of the main chassis, the installation of the concrete batching plant begins.

Depending on the type of concrete plant (stationary plants, mobile plants, container concrete batching plants, etc.), it can be sent to the place where it will be installed without installation. Immediately after the assembly process of the power plant is completed, the power plant is carefully placed on the concrete legs with the help of a crane. Anchors located at the feet of the concrete batching plant ensure that the concrete is fixed to the plant. Immediately after, the silos are placed on the concrete feet according to the project given by the company and fixed to the concrete. The spirals that allow the cement to pass into the concrete plant are placed between the silo plant properly. Our company has all the technical information about the second hand concrete batching plant for sale.

After the aggregate feeding band and aggregate hopper are carefully placed on the concrete floor, the installation process ends. Then, all load cells to be used in the plant are measured and the automation system is controlled and the plant is made ready for operation. The concrete batching plant is delivered to the customer by our company immediately after the necessary trials are made.

In the dismantling process of concrete plants, first the aggregate bunkers, spirals and cement silos are emptied and cleaned. The concrete plant is disconnected from the main energy line and after the dismantling process is completed, it is loaded on vehicles and sent to the relevant place.

Our concrete batching plants come to the areas requested by the companies by the technical personnel and carefully perform the installation and dismantling of the plants. Our concrete batching plants are under warranty by our company and necessary procedures are carried out to solve any technical problem. Many customers prefer our company because it is both economical and under warranty. You can contact our company for a concrete batching plant for sale by its owner..



# REFERENCES

İKOLİN İNŞAAT 60 m3 SABİT BETON SANTRALİ  
BAYBURT GROUP A.Ş. 100 m3 MOBİL BETON SANTRALİ  
ERHAN BAL İNŞAAT 60 m3 MOBİL BETON SANTRALİ  
PAŞASA İNŞAAT 100 m3 MOBİL BETON SANTRALİ  
DOĞA HAZIR BETON 100 m3 SABİT BETON SANTRALİ  
ÖNERİŞ İNŞAAT 60 m3 MOBİL BETON SANTRALİ  
HGG İNŞAAT 60 m3 MOBİL BETON SANTRALİ  
ACUNLAR İNŞAAT 100 m3 SABİT BETON SANTRALİ  
ERDOĞANLAR İNŞAAT 100 m3 SABİT BETON SANTRALİ  
TEZEL BETON 100 m3 SABİT BETON SANTRALİ  
DALGIÇLAR BETON 130 M3 FIXED CONCRETE BATCHING PLANT  
QUAVIAN GRUP 200 M3 FIXED CONCRETE BATCHING PLANT  
HOBCTPON 130 M3 FIXED CONCRETE BATCHING PLANT  
AGT AZVIRT 130 M3 FIXED CONCRETE BATCHING PLANT  
KAEBIL CO 60 M3 FIXED CONCRETE BATCHING PLANT MOBİL  
CALLES BETONGPUMP 130 M3 FIXED CONCRETE BATCHING PLANT  
YENİGÜN İNŞAAT 60 M3 FIXED CONCRETE BATCHING PLANT MOBİL  
KARABEYOĞLU HAZIR BETON 130 M3 FIXED CONCRETE BATCHING PLANT  
SÜHA BETON 160 M3 FIXED CONCRETE BATCHING PLANT  
AKPINAR İNŞAAT 130 M3 FIXED CONCRETE BATCHING PLANT  
ALAGÖZLER BETON 130 M3 FIXED CONCRETE BATCHING PLANT  
NAS BETON 130 M3 FIXED CONCRETE BATCHING PLANT  
Pİ YAPI 60 M3 FIXEDCONCRETE BATCHING PLANT MOBİL  
EL-KA BETON 100 M3 FIXEDCONCRETE BATCHING PLANT  
FİBER ELEKTRİK 60 M3 FIXEDCONCRETE BATCHING PLANT MOBİL  
HCG İNŞAAT VE TİC. A.Ş 130 M3 FIXEDCONCRETE BATCHING PLANT  
YUNUS İNŞAAT 35 M3 FIXEDCONCRETE BATCHING PLANT  
NSN İNŞAAT 60 M3 FIXEDCONCRETE BATCHING PLANT MOBİL  
ASDUR BETON 130 M3 FIXEDCONCRETE BATCHING PLANT





# CONTACT

## FACTORY - CONTACT INFORMATION

INTERNATIONAL SALES MANAGER

WHATSAPP :+90 537 990 62 51

Phone: +90 312 394 65 63 - Fax: +90 312 394 65 53

GSM : +90 505 999 63 06

Factory : Dağyaka Mah. 2008. Cad. No:1/1 Kahramankazan/ANKARA/TURKEY

E-mail : info@asurmakina.com.tr

<https://linktr.ee/asurmak>





# PRODUCT CATALOGUE

[www.asurmakina.com.tr](http://www.asurmakina.com.tr)

